

GENERAL DESCRIPTION

The SGM48017/8/9 are high-speed gate drivers capable of effectively driving MOSFET and IGBT power switches. They allow for up to 8A source and 13A sink peak currents at $V_{DD} = 20V$. The SGM48017/8/9 provide a set of comprehensive protection features such as thermal shutdown protection, under-voltage lockout and short-circuit protection. They operate with a wide supply range of 4.5V to 20V.

The SGM48017/8/9 are available in a Green SOT-23-5 package. They operate over a temperature range of $-40^{\circ}C$ to $+125^{\circ}C$.

APPLICATIONS

- Power MOSFETs
- IGBT Driving for Power Supplies
- Motor Drivers

FEATURES

- Simple and Reliable
- 8A Source and 13A Sink Peak Currents
- Wide Supply Voltage Range: 4.5V to 20V
- Fast Propagation Delay: 30ns (TYP)
- Fast Rise Time: 7ns (TYP)
- Fast Fall Time: 8ns (TYP)
- Ringing Suppression
- Negative Voltage Capability on INx Pin:
 - 10V when $(V_{DD} - V_{INx}) \leq 22V$
- Negative Voltage Capability on EN Pin:
 - 10V when $(V_{DD} - V_{EN}) \leq 22V$
- Negative Voltage Capability on OUT Pin:
 - 5V (Pulse < 500ns)
- Comprehensive Protection Features
 - Thermal Shutdown Protection
 - Under-Voltage Lockout
 - Short-Circuit Protection
- $-40^{\circ}C$ to $+125^{\circ}C$ Operating Temperature Range
- Available in a Green SOT-23-5 Package

TYPICAL APPLICATIONS

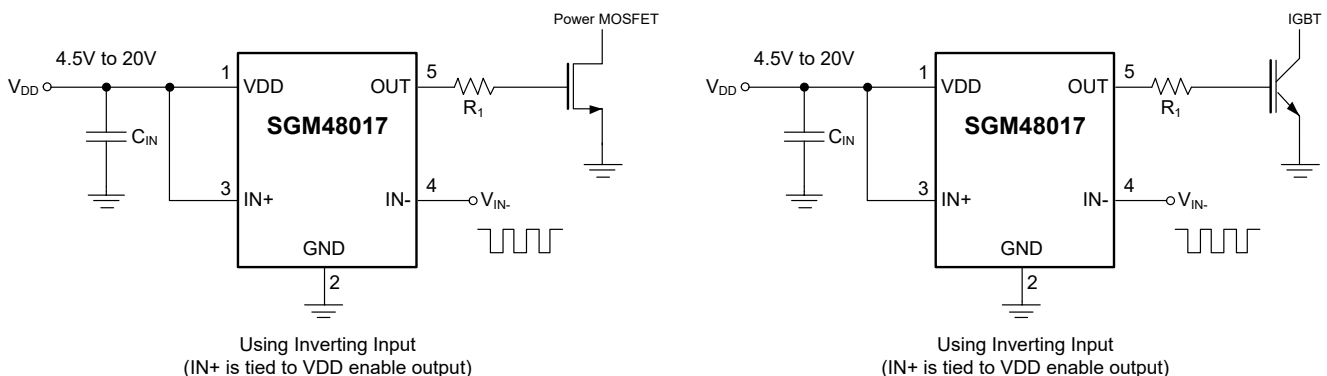
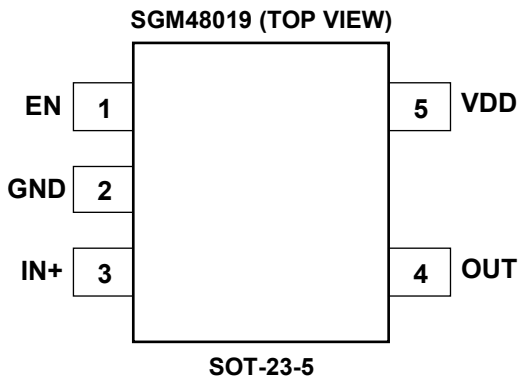
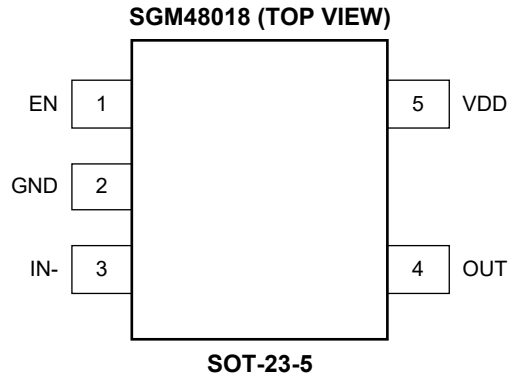
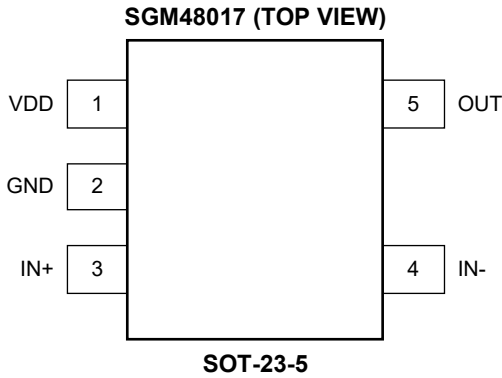

Figure 1. Typical Application Circuits

Power MOSFET and IGBT Gate Drivers with Comprehensive Protections

PIN CONFIGURATIONS



PIN DESCRIPTION

PIN			NAME	I/O	FUNCTION
SGM48017	SGM48018	SGM48019			
1	5	5	VDD	P	Supply Input. Place a 4.7μF decoupling capacitor between this pin and GND pin close to the device.
2	2	2	GND	G	Ground. All signals are referenced to this pin.
3	—	3	IN+	I	Non-Inverting Input. OUT is held low if IN+ is floating. For the SGM48017, when the driver is used in inverting configuration, pull IN+ high in order to enable output.
4	3	—	IN-	I	Inverting Input. OUT is held low if IN- is floating. For the SGM48017, when the driver is used in non-inverting configuration, pull IN- low in order to enable output.
5	4	4	OUT	O	Source/Sink Current Output of Driver.
—	1	1	EN	I	Enable Input. EN is biased low to disable output regardless of input state. EN is biased high or left floating to enable output. EN is allowed to float.

NOTE:
P: power supply, I: input, O: output, G: ground.

Power MOSFET and IGBT Gate Drivers SGM48017/SGM48018/SGM48019 with Comprehensive Protections

ELECTRICAL CHARACTERISTICS

(V_{DD} = 12V, C_{IN} = 4.7μF, typical values are at T_J = +25°C, Full = -40°C to +125°C, unless otherwise noted.)

PARAMETER	SYMBOL	CONDITIONS	TEMP	MIN	TYP	MAX	UNITS
Power Supplies							
VDD Operating Supply Voltage	V _{DD}		Full	4.5		20	V
VDD Operating Supply Current	I _{VDD}	INx, EN floating	+25°C		90	120	μA
		V _{IN+} = 5V, V _{IN-} = 0V, SGM48017 only	+25°C		750	960	
		V _{EN} = 5V, V _{IN-} = 0V, SGM48018 only	+25°C		815	1040	
		V _{EN} = 5V, V _{IN+} = 5V, SGM48019 only	+25°C		775	990	
VDD Under-Voltage Lockout Voltage	V _{UVLO}	V _{DD} rising	Full	3.8	4.1	4.4	V
VDD Under-Voltage Lockout Voltage Hysteresis	V _{HYS}		+25°C		200		mV
Inputs (INx, EN)							
Input Low Voltage	V _{IL}		Full			0.7	V
Input High Voltage	V _{IH}		Full	2.5			V
Input Low Current	I _{IL}	Inverting input current, V _{INx} = 0V	+25°C		110	140	μA
		Non-inverting input current, V _{INx} = 0V	+25°C		0.1	1	
Input High Current	I _{IH}	Inverting input current, V _{INx} = 20V	+25°C		0.2	2	μA
		Non-inverting input current, V _{INx} = 20V	+25°C		115	150	
EN Low Current	I _{ENL}	V _{EN} = 0V	+25°C		110	145	μA
EN High Current	I _{ENH}	V _{EN} = 20V	+25°C		0.2	2	μA
Outputs							
Pull-Up Resistance ⁽¹⁾	R _{OH}	V _{DD} = 12V, I _{OUT_SOURCE} = 50mA	Full		4.7	7.4	Ω
		V _{DD} = 4.5V, I _{OUT_SOURCE} = 50mA	Full		5.3	8.3	
Pull-Down Resistance	R _{OL}	V _{DD} = 12V, I _{OUT_SINK} = -50mA	Full		255	440	mΩ
		V _{DD} = 4.5V, I _{OUT_SINK} = -50mA	Full		265	460	
Peak Output Current	I _{PK_SOURCE}	V _{DD} = 20V, C _L = 0.22μF, f _{SW} = 1kHz	+25°C		8		A
	I _{PK_SINK}		+25°C		13		A
Switching Characteristics							
Rise Time	t _R	C _L = 2.2nF, see Figure 2 through Figure 9	+25°C		7		ns
Fall Time	t _F		+25°C		8		ns
Propagation Delay (IN+) to OUT	t _{D1}	C _L = 2.2nF, 3V input pulse, see Figure 2, Figure 4 and Figure 8	+25°C		26		ns
	t _{D2}		+25°C		30		ns
Propagation Delay (IN-) to OUT	t _{D3}	C _L = 2.2nF, 3V input pulse, see Figure 3, Figure 5 and Figure 6	+25°C		30		ns
	t _{D4}		+25°C		26		ns
Propagation Delay (EN) to OUT	t _{D5}	C _L = 2.2nF, 3V input pulse, see Figure 7 and Figure 9	+25°C		26		ns
	t _{D6}		+25°C		30		ns
Protection Circuits							
Thermal Shutdown Temperature	T _{TSD}				165		°C
Thermal Shutdown Temperature Hysteresis	T _{HYS}				30		°C

NOTE:

1. R_{OH} represents constant pull-up resistance only. Pull-up resistance R_{OH_PULSE} operates in pulse mode during the output rising stage, R_{OH_PULSE} = 565mΩ (TYP).

Power MOSFET and IGBT Gate Drivers with Comprehensive Protections

SGM48017/SGM48018/SGM48019

TYPICAL PERFORMANCE CHARACTERISTICS

At $T_J = +25^\circ\text{C}$, $V_{DD} = 12\text{V}$, $C_{IN} = 4.7\mu\text{F}$, unless otherwise noted.

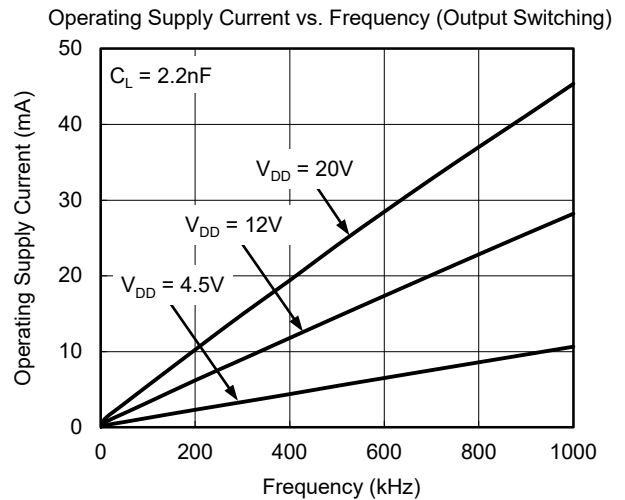
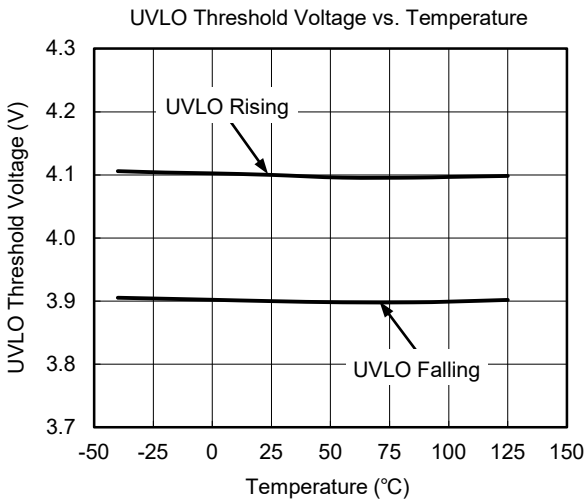
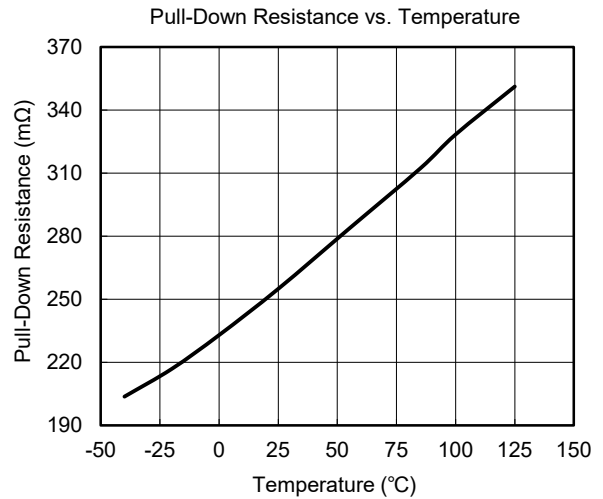
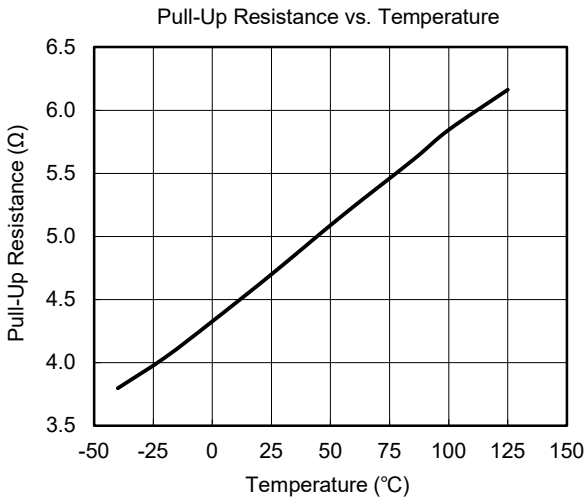
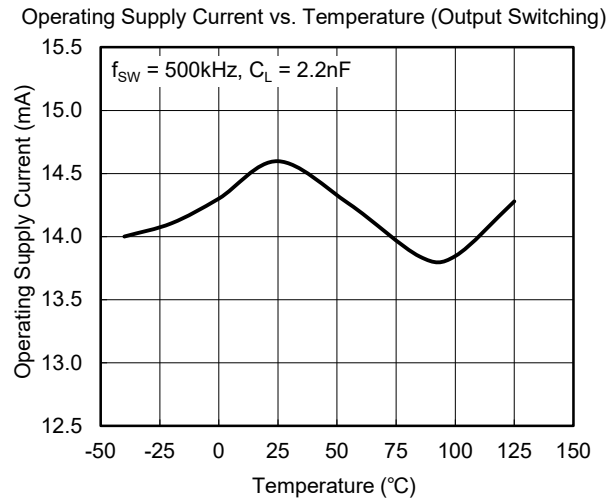
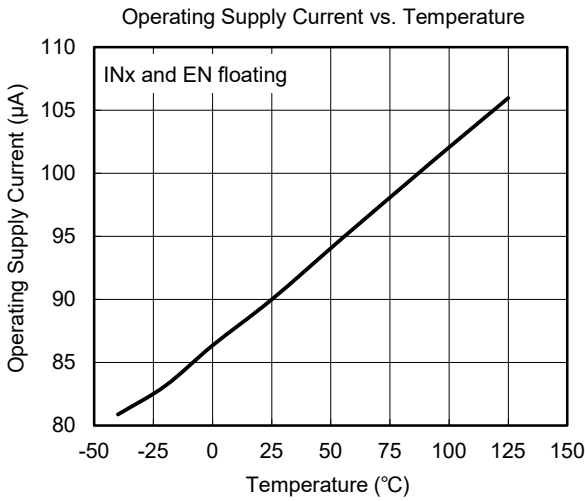

Power MOSFET and IGBT Gate Drivers with Comprehensive Protections

SGM48017/SGM48018/SGM48019

TYPICAL PERFORMANCE CHARACTERISTICS (continued)

At $T_J = +25^\circ\text{C}$, $V_{DD} = 12\text{V}$, $C_{IN} = 4.7\mu\text{F}$, unless otherwise noted.

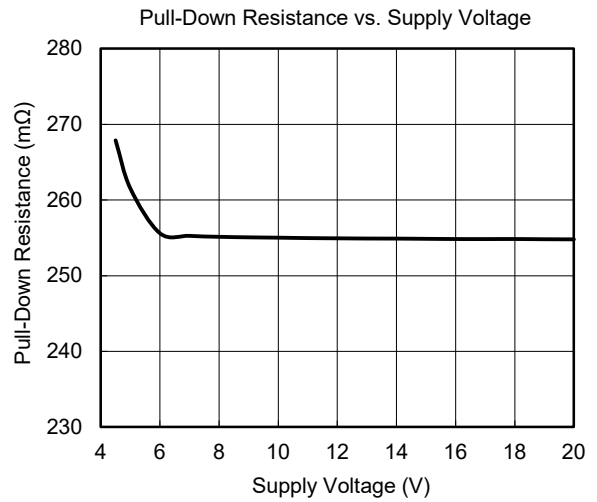
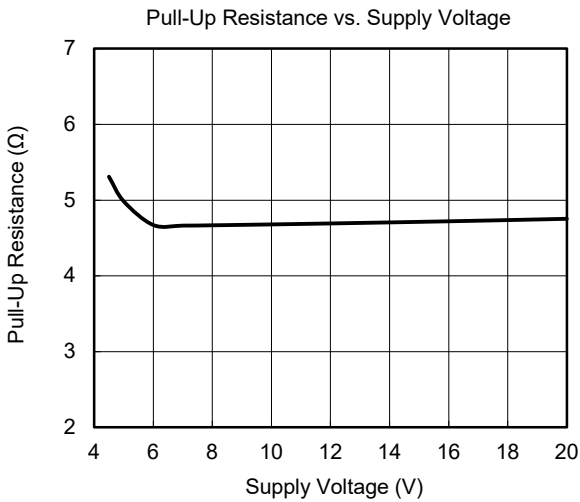
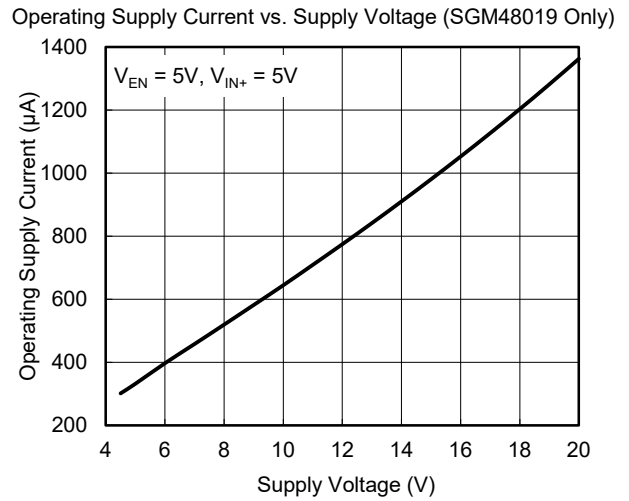
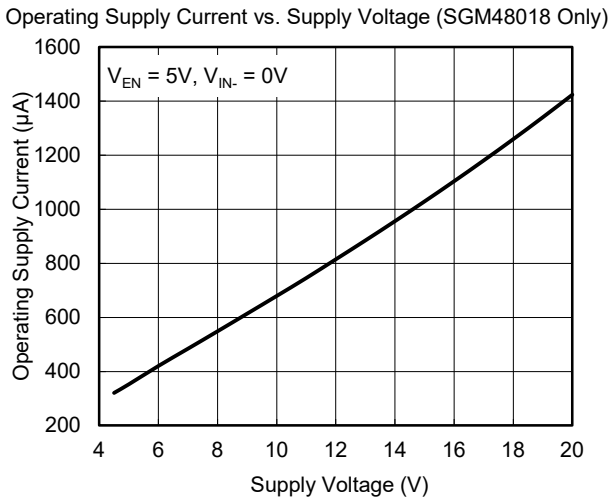
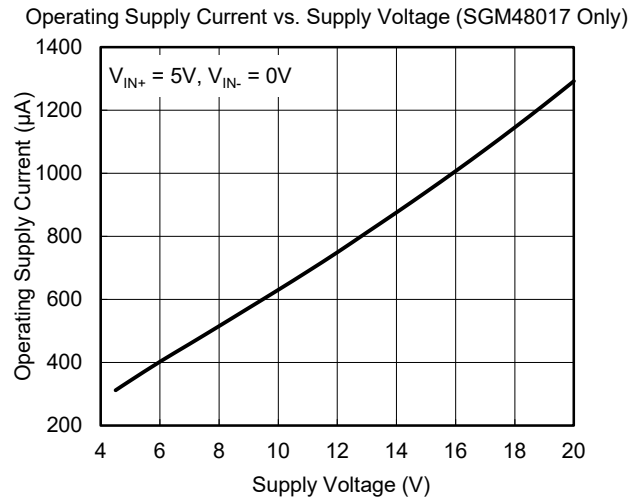
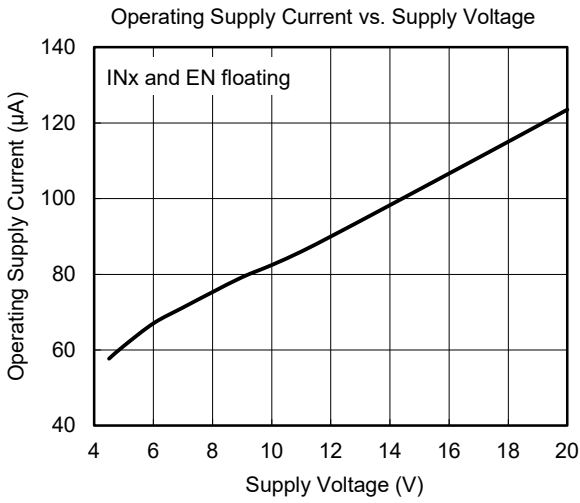

Power MOSFET and IGBT Gate Drivers SGM48017/SGM48018/SGM48019 with Comprehensive Protections

TYPICAL PERFORMANCE CHARACTERISTICS (continued)

At $T_J = +25^\circ\text{C}$, $V_{DD} = 12\text{V}$, $C_{IN} = 4.7\mu\text{F}$, unless otherwise noted.

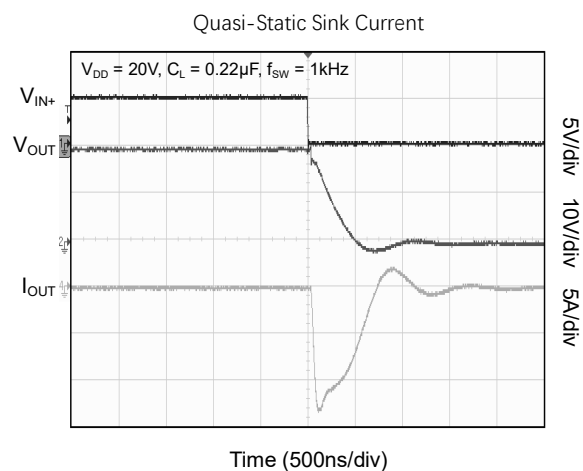
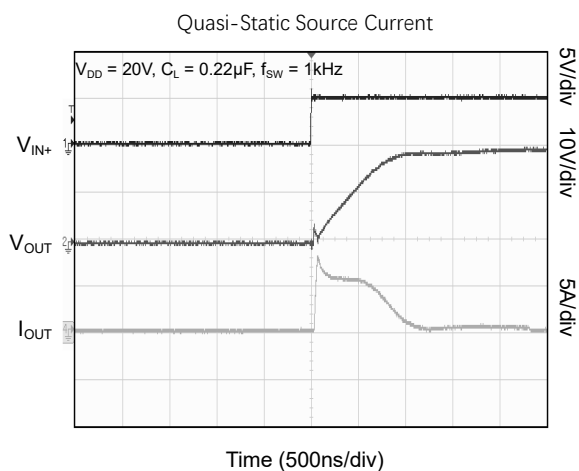

TIMING DIAGRAMS

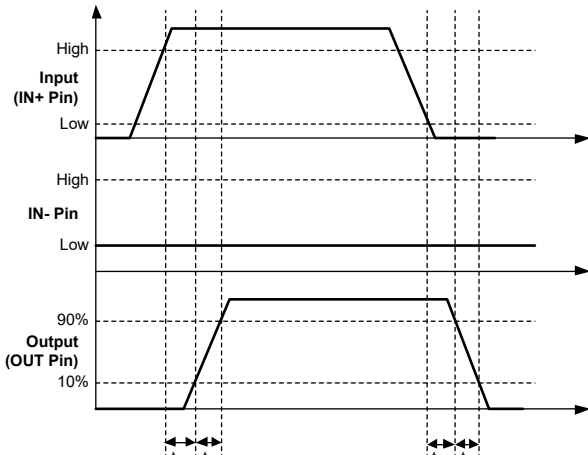

(PWM Input to IN+ Pin (IN- Pin Tied Low), SGM48017)

Figure 2. Non-Inverting Configuration

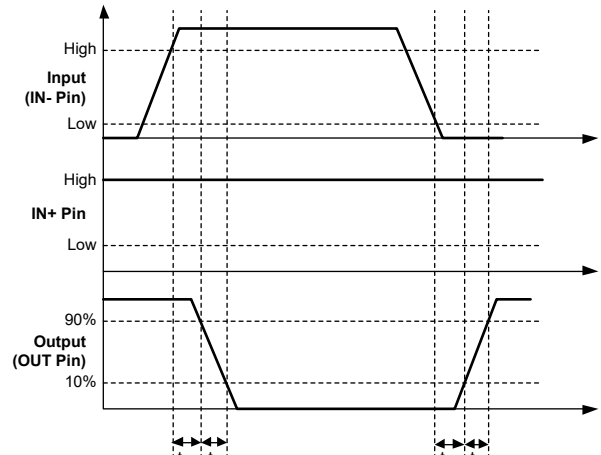

(PWM Input to IN- Pin (IN+ Pin Tied High), SGM48017)

Figure 3. Inverting Configuration

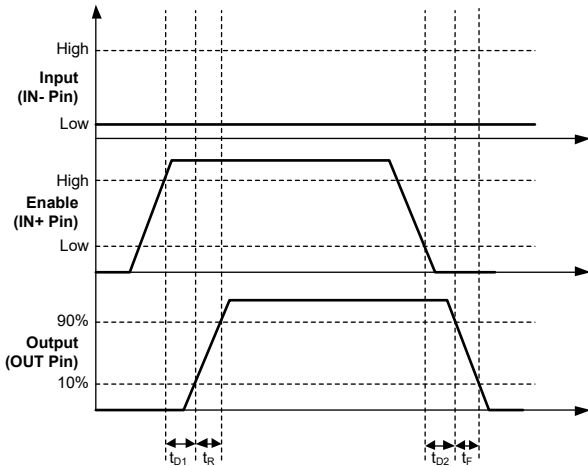

(Enable Signal Applied to IN+ Pin, PWM Input to IN- Pin, SGM48017)

Figure 4. Enable and Disable Functions Using IN+ Pin

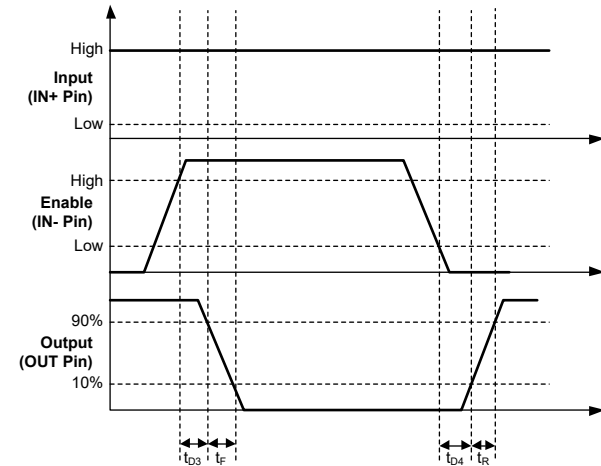

(Enable Signal Applied to IN- Pin, PWM Input to IN+ Pin, SGM48017)

Figure 5. Enable and Disable Functions Using IN- Pin

TIMING DIAGRAMS (continued)

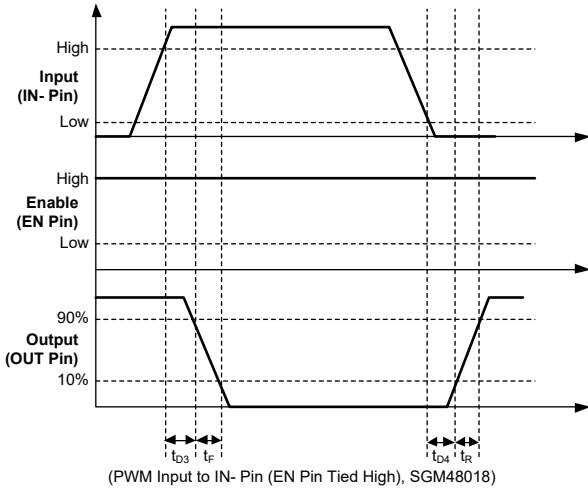

Figure 6. Inverting Configuration

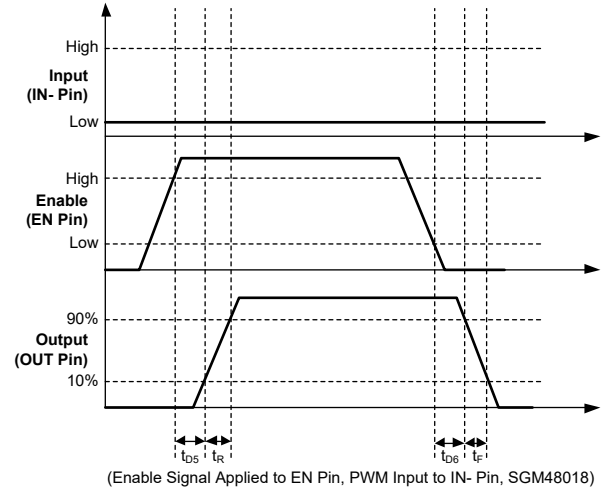

Figure 7. Enable and Disable Functions Using EN Pin

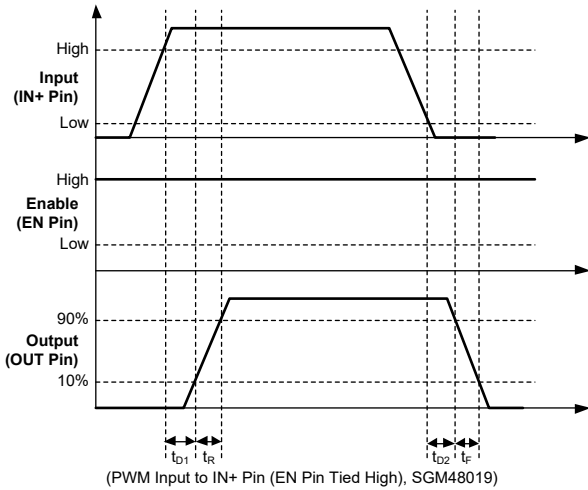

Figure 8. Non-Inverting Configuration

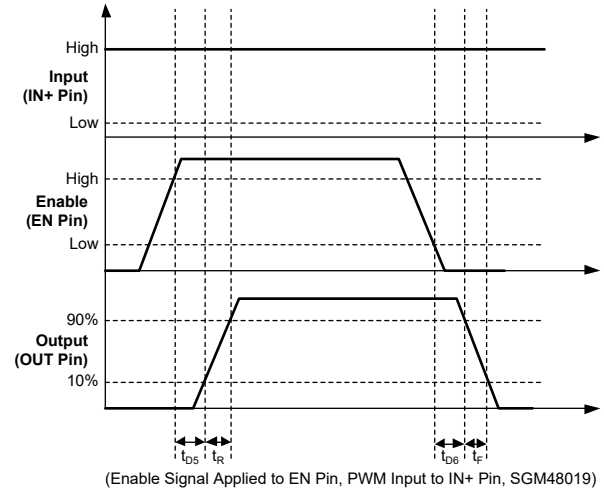

Figure 9. Enable and Disable Functions Using EN Pin

Power MOSFET and IGBT Gate Drivers SGM48017/SGM48018/SGM48019 with Comprehensive Protections

FUNCTION TABLE

SGM48017			SGM48018			SGM48019		
IN+	IN-	OUT	EN	IN-	OUT	EN	IN+	OUT
L	L	L	L	L	L	L	L	L
L	H	L	L	H	L	L	H	L
H	L	H	H	L	H	H	L	L
H	H	L	H	H	L	H	H	H
-	Floating	L	Floating	L	H	Floating	L	L
Floating	-	L	Floating	H	L	Floating	H	H
-	-	-	-	Floating	L	-	Floating	L

FUNCTIONAL BLOCK DIAGRAMS

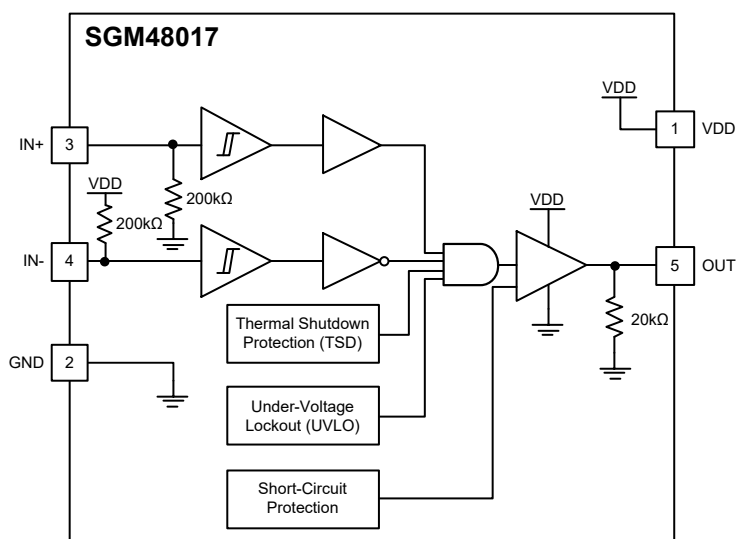

Figure 10. SGM48017 Block Diagram

FUNCTIONAL BLOCK DIAGRAMS (continued)

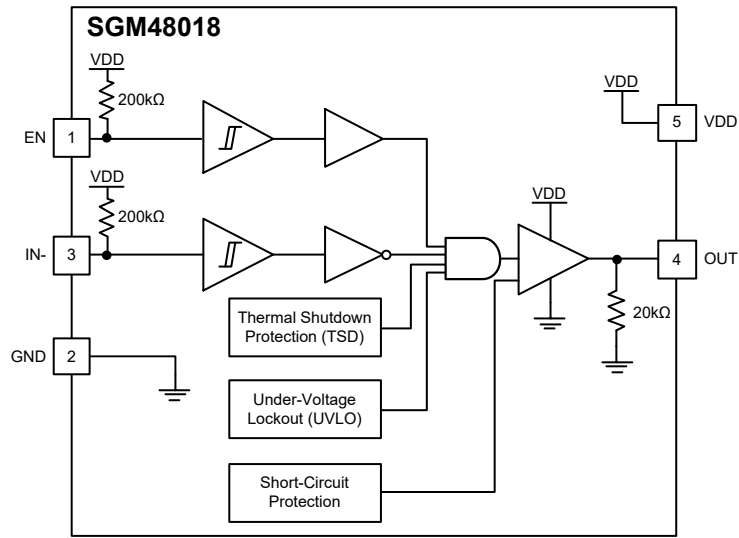

Figure 11. SGM48018 Block Diagram

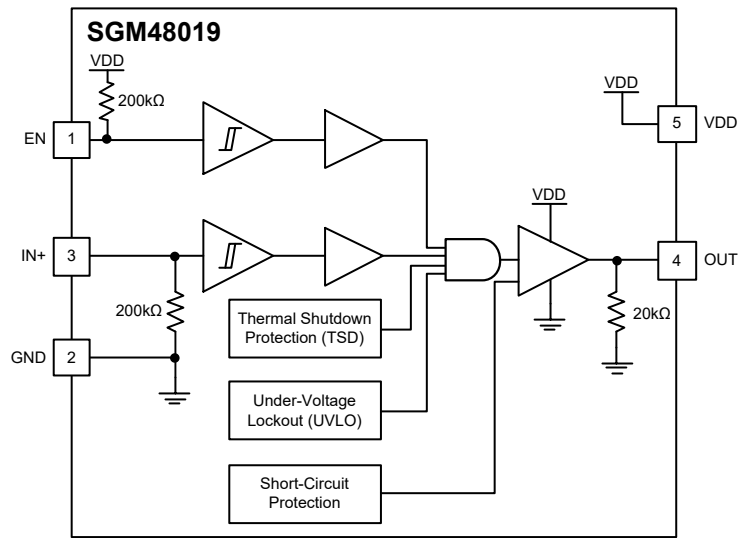

Figure 12. SGM48019 Block Diagram

DETAILED DESCRIPTION

The SGM48017/8/9 are reliable and high-speed gate drivers for power MOSFETs and IGBTs with a comprehensive set of protection features such as thermal shutdown protection, under-voltage lockout and short-circuit protection. The outputs are forced low immediately if any of the above mentioned conditions occurs, except short-circuit protection. When

short-circuit protection occurs, the outputs enter into high impedance, and the driver will be re-enabled after the protection period (16ms, TYP) expires.

The SGM48017/8/9 offer a unique output stage design. It can effectively suppress the output voltage ringing and the overshoot/undershoot on the outputs.

Power MOSFET and IGBT Gate Drivers SGM48017/SGM48018/SGM48019 with Comprehensive Protections

REVISION HISTORY

NOTE: Page numbers for previous revisions may differ from page numbers in the current version.

Changes from Original (SEPTEMBER 2020) to REV.A

Page

Changed from product preview to production data.....	All
--	-----

PACKAGE INFORMATION

PACKAGE OUTLINE DIMENSIONS

SOT-23-5

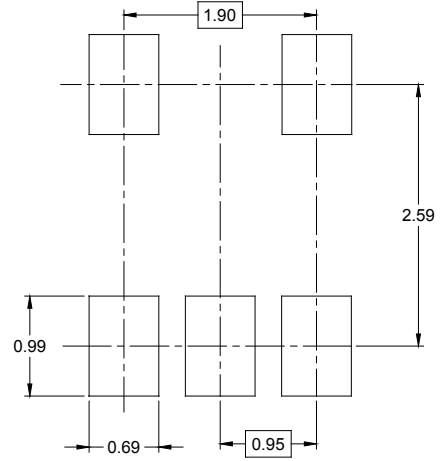
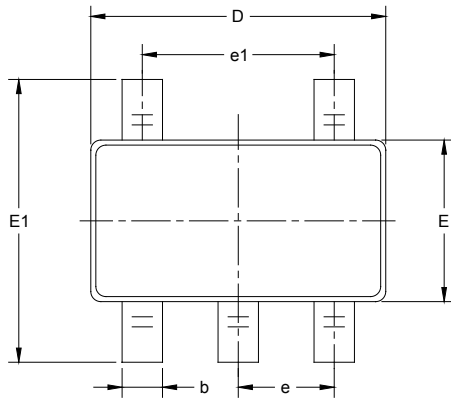

RECOMMENDED LAND PATTERN (Unit: mm)

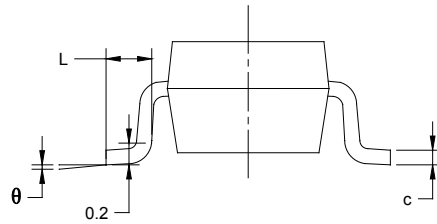
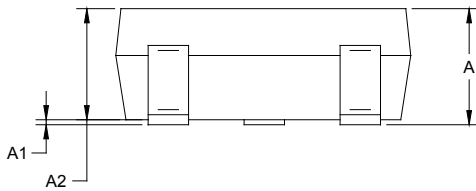

Symbol	Dimensions In Millimeters		Dimensions In Inches	
	MIN	MAX	MIN	MAX
A	1.050	1.250	0.041	0.049
A1	0.000	0.100	0.000	0.004
A2	1.050	1.150	0.041	0.045
b	0.300	0.500	0.012	0.020
c	0.100	0.200	0.004	0.008
D	2.820	3.020	0.111	0.119
E	1.500	1.700	0.059	0.067
E1	2.650	2.950	0.104	0.116
e	0.950 BSC		0.037 BSC	
e1	1.900 BSC		0.075 BSC	
L	0.300	0.600	0.012	0.024
θ	0°	8°	0°	8°

PACKAGE INFORMATION

TAPE AND REEL INFORMATION

REEL DIMENSIONS



TAPE DIMENSIONS



NOTE: The picture is only for reference. Please make the object as the standard.

KEY PARAMETER LIST OF TAPE AND REEL

Package Type	Reel Diameter	Reel Width W1 (mm)	A0 (mm)	B0 (mm)	K0 (mm)	P0 (mm)	P1 (mm)	P2 (mm)	W (mm)	Pin1 Quadrant
SOT-23-5	7"	9.5	3.20	3.20	1.40	4.0	4.0	2.0	8.0	Q3

000001

PACKAGE INFORMATION

CARTON BOX DIMENSIONS



NOTE: The picture is only for reference. Please make the object as the standard.

KEY PARAMETER LIST OF CARTON BOX

Reel Type	Length (mm)	Width (mm)	Height (mm)	Pizza/Carton
7" (Option)	368	227	224	8
7"	442	410	224	18

DD0002