

SGMICRO

SGM58031Q

Ultra-Small, Low-Power, 16-Bit Analog-to-Digital Converter with Internal Reference

GENERAL DESCRIPTION

The SGM58031Q is a low-power, 16-bit, precision, delta-sigma ($\Delta\Sigma$) analog-to-digital converter (ADC). It operates from a 3V to 5.5V supply.

The SGM58031Q contains an on-chip reference and oscillator. It has an I²C-compatible interface, and it can select four I²C slave addresses. The data rate of the filter is up to 960SPS. The SGM58031Q has an on-chip PGA, which can provide input ranges to as low as $\pm 256\text{mV}$ from the power supply.

The input multiplexer supports 4 single-ended inputs or 2 differential inputs configuration.

The SGM58031Q is AEC-Q100 qualified (Automotive Electronics Council Standard Q100 Grade 1) and the use of this device is suitable for automotive applications.

The SGM58031Q is available in a Green MSOP-10 package. It operates over an ambient temperature range of -40°C to $+125^{\circ}\text{C}$.

FEATURES

- **AEC-Q100 Qualified for Automotive Applications Device Temperature Grade 1**
 $T_A = -40^{\circ}\text{C}$ to $+125^{\circ}\text{C}$
- **Single-Supply Voltage Range: 3V to 5.5V**
 - ◆ **I²C Bus Voltage Range: 3V to 5.5V**
- **Low Quiescent Current:**
 - ◆ **Continuous Mode: 255 μA (TYP)**
 - ◆ **Power-Down Mode: 0.8 μA (TYP)**
- **Selectable Data Rates: 6.25SPS to 960SPS**
- **Input Multiplexer**
 - ◆ **4 Single-Ended Inputs or 2 Differential Inputs**
- **Internal Programmable Gain Amplifier (PGA)**
- **Internal Voltage Reference and Oscillator**
- **Selectable Digital Comparator**
- **I²C-Compatible Serial Interface**
- **Available in a Green MSOP-10 Package**

APPLICATIONS

Automotive Applications
 Portable Devices
 Process Control
 Battery Monitoring System
 Temperature Measurement

Ultra-Small, Low-Power, 16-Bit

Analog-to-Digital Converter with Internal Reference

SGM58031Q

PACKAGE/ORDERING INFORMATION

MODEL	PACKAGE DESCRIPTION	SPECIFIED TEMPERATURE RANGE	ORDERING NUMBER	PACKAGE MARKING	PACKING OPTION
SGM58031Q	MSOP-10	-40°C to +125°C	SGM58031QMS10G/TR	055 MS10 XXXXX	Tape and Reel, 4000

MARKING INFORMATION

NOTE: XXXXX = Date Code, Trace Code and Vendor Code.

XXXXX

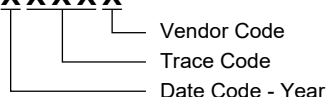

Green (RoHS & HSF): SG Micro Corp defines "Green" to mean Pb-Free (RoHS compatible) and free of halogen substances. If you have additional comments or questions, please contact your SGMICRO representative directly.

ABSOLUTE MAXIMUM RATINGS

Voltage Range (with Respect to GND)

V_{DD}	-0.3V to 5.5V
Analog Input Voltage.....	-0.3V to 5.5V
SDA, SCL, ADDR, ALERT/RDY Voltage	-0.3V to 5.5V
Input Current (Momentary).....	100mA
Input Current (Continuous)	10mA
Junction Temperature.....	+150°C
Storage Temperature Range	-65°C to +150°C
Lead Temperature (Soldering, 10s).....	+260°C
ESD Susceptibility	
HBM.....	4000V
CDM	1000V

RECOMMENDED OPERATING CONDITIONS

Operating Temperature Range-40°C to +125°C

OVERSTRESS CAUTION

Stresses beyond those listed in Absolute Maximum Ratings may cause permanent damage to the device. Exposure to absolute maximum rating conditions for extended periods may affect reliability. Functional operation of the device at any conditions beyond those indicated in the Recommended Operating Conditions section is not implied.

ESD SENSITIVITY CAUTION

This integrated circuit can be damaged if ESD protections are not considered carefully. SGMICRO recommends that all integrated circuits be handled with appropriate precautions. Failure to observe proper handling and installation procedures can cause damage. ESD damage can range from subtle performance degradation to complete device failure. Precision integrated circuits may be more susceptible to damage because even small parametric changes could cause the device not to meet the published specifications.

DISCLAIMER

SG Micro Corp reserves the right to make any change in circuit design, or specifications without prior notice.

Ultra-Small, Low-Power, 16-Bit SGM58031Q Analog-to-Digital Converter with Internal Reference

PIN CONFIGURATION

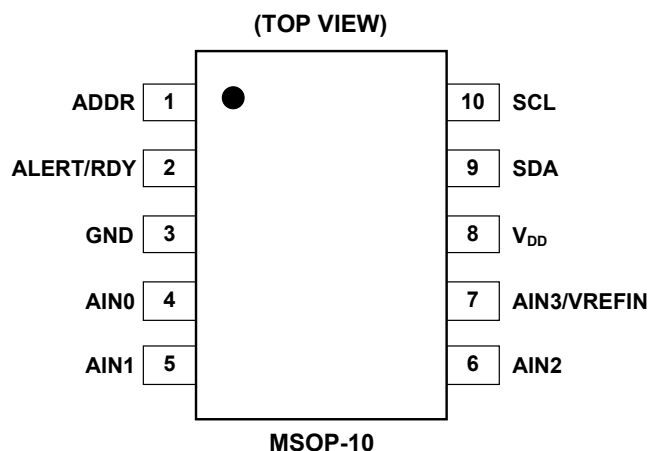

PIN DESCRIPTION

PIN	NAME	TYPE ⁽¹⁾	FUNCTION
1	ADDR	DI	I ² C Address Selection Pin.
2	ALERT/RDY	DO	Digital Comparator Output/Conversion Ready Pin.
3	GND	G	Ground.
4	AIN0	AI	Positive Input of Differential Channel 1 or Input of Single-Ended Channel 1.
5	AIN1	AI	Negative Input of Differential Channel 1 or Input of Single-Ended Channel 2.
6	AIN2	AI	Positive Input of Differential Channel 2 or Input of Single-Ended Channel 3.
7	AIN3/VREFIN	AI	Negative Input of Differential Channel 2 or Input of Single-Ended Channel 4, or External Reference Input.
8	V _{DD}	P	Power Supply Pin. It can be operated from 3V to 5.5V.
9	SDA	DIO	Serial Data Pin.
10	SCL	DI	Serial Clock Input Pin.

NOTE:

1. AI = Analog Input, DI = Digital Input, DO = Digital Output, DIO = Digital Input and Output, P = Power, G = Ground.

Ultra-Small, Low-Power, 16-Bit

SGM58031Q Analog-to-Digital Converter with Internal Reference

ELECTRICAL CHARACTERISTICS

($V_{DD} = 3.3V$, Full-Scale (FS) = $\pm 2.048V$, maximum and minimum specifications apply from $T_A = -40^{\circ}C$ to $+125^{\circ}C$, typical values are at $T_A = +25^{\circ}C$, unless otherwise noted.)

PARAMETER	SYMBOL	CONDITIONS	MIN	TYP	MAX	UNITS
Analog Input						
Full-Scale Input Voltage ⁽¹⁾		$V_{IN} = AIN_P - AIN_N$		$\pm 4.096/PGA$		V
Analog Input Voltage		AIN_P or AIN_N to GND	GND		V_{DD}	V
Differential Input Impedance				See Table 1		
System Performance						
Resolution		No missing codes	16			Bits
Data Rate	DR			See Table 5		SPS
Data Rate Variation		All data rates	-6		6	%
Output Noise			See Table 6 and Table 7			
Integral Nonlinearity	INL	DR = 8SPS, FS = $\pm 2.048V$, best fit (99% of full-scale)		1	4	LSB
Offset Error		FS = $\pm 2.048V$	differential inputs	1	5	LSB
			single-ended inputs	2	8.5	
Offset Drift		FS = $\pm 2.048V$		0.005	0.06	LSB/ $^{\circ}C$
Offset Power Supply Rejection		FS = $\pm 2.048V$		1.2		LSB/V
Gain Error ⁽²⁾		FS = $\pm 2.048V$ at $+25^{\circ}C$		0.03	0.3	%
Gain Drift ⁽³⁾		FS = $\pm 0.256V$		30		ppm/ $^{\circ}C$
		FS = $\pm 2.048V$		30	70	
		FS = $\pm 6.144V$ ⁽¹⁾		30		
Gain Power Supply Rejection				50	200	ppm/V
PGA Gain Match ⁽²⁾		Match between any two PGA gains		0.1	0.28	%
Gain Match		Match between any two inputs		0.01	0.08	%
Offset Match		Match between any two gains		1	8.5	LSB
50/60Hz Rejection		FS = $\pm 2.048V$		95		dB
Channel-to-Channel Crosstalk		At DC and FS = $\pm 2.048V$, differential or single-ended inputs adjacent channels		90		dB
Common-Mode Rejection Ratio	CMRR	At DC and FS = $\pm 0.256V$		110		dB
		At DC and FS = $\pm 2.048V$		110		
		At DC and FS = $\pm 6.144V$ ⁽¹⁾		110		
Internal Clock						
Frequency			386	410	434	kHz

NOTES:

- The full-scale range of the ADC scaling. In any event, the voltage applied to this device should not exceed $V_{DD} + 0.3V$.
- It includes all errors from on-chip PGA and reference.
- Gain temperature drift is defined as the maximum change of gain error measured over the specified temperature range. The gain error drift is calculated using the box method, as described by Equation: $Gain\ Error\ Drift = (GE_{MAX} - GE_{MIN}) / (T_{MAX} - T_{MIN})$.
Where:
 - GE_{MAX} and GE_{MIN} are the maximum and minimum gain errors, respectively.
 - T_{MAX} and T_{MIN} are the maximum and minimum temperatures, respectively, which is over the temperature range $-40^{\circ}C$ to $+125^{\circ}C$.

Ultra-Small, Low-Power, 16-Bit

Analog-to-Digital Converter with Internal Reference

SGM58031Q

ELECTRICAL CHARACTERISTICS (continued)

($V_{DD} = 3.3V$, Full-Scale (FS) = $\pm 2.048V$, maximum and minimum specifications apply from $T_A = -40^{\circ}C$ to $+125^{\circ}C$, typical values are at $T_A = +25^{\circ}C$, unless otherwise noted.)

PARAMETER	SYMBOL	CONDITIONS	MIN	TYP	MAX	UNITS
Reference						
Internal Reference				2.048		V
External Reference			0.5		2.5	V
External Reference Input Current		$V_{REFIN} = 2.5V$, continuous mode		0.45		μA
Digital Input/Output						
High Input Voltage ⁽⁴⁾	V_{IH}		$0.7 \times V_{BUS}$			V
Low Input Voltage ⁽⁴⁾	V_{IL}				$0.3 \times V_{BUS}$	V
Low Output Voltage	V_{OL}	$I_{OL} = 3mA$		0.07	0.4	V
High Input Leakage Current ⁽⁵⁾	I_{IH}	$V_{IH} = 5.5V$		0.1	1	μA
Low Input Leakage Current ⁽⁵⁾	I_{IL}	$V_{IL} = GND$		0.1	1	μA
Power Supply Requirements						
Power Supply Voltage	V_{DD}		3		5.5	V
Supply Current	I_{DD}	$V_{DD} = V_{BUS} = 5.5V$	Power-down current at $+25^{\circ}C$	0.8	1	μA
			Power-down current up to $+125^{\circ}C$	1.8	3.8	
			Operating current at $+25^{\circ}C$	255	320	
			Operating current up to $+125^{\circ}C$	270	340	
Power Dissipation	P_D	$V_{DD} = 5V$		1.05		mW
		$V_{DD} = 3.3V$		0.6		

NOTES:

4. There are 2 scenarios: $V_{DD} = 5V$, V_{BUS} can be 3V to 5V. $V_{DD} = 3.3V$, V_{BUS} should be 3.3V. Note that $V_{BUS} = 3V$ may cause leakage in some extreme conditions, and it is better to make it higher than 3.1V. For $V_{BUS} = V_{DD}$, $V_{IL}/V_{IH} = 30\%/70\%$ of V_{BUS} . For $V_{BUS} = 3.3V$ and $V_{DD} = 5V$, $V_{IL}/V_{IH} = 20\%/80\%$ of V_{BUS} .

5. Meet the "loss of V_{DD} " requirement of I^2C fast mode. When V_{DD} is lost, the leakage drawn from the pin is controlled.

TIMING CHARACTERISTICS

PARAMETER	SYMBOL	STANDARD MODE		FAST MODE		HIGH-SPEED MODE		UNITS
		MIN	MAX	MIN	MAX	MIN	MAX	
SCL Operating Frequency	f_{SCL}	0.01	0.1	0.01	0.4	0.01	3.4	MHz
Bus Free Time between START and STOP Condition	t_1	4700		600		160		ns
Hold Time after Repeated START Condition. After This Period, the First Clock is Generated	t_2	4000		600		160		ns
SCL Clock Low Time	t_3	4700		1300		160		ns
SCL Clock High Time	t_7	4000		600		60		ns
Repeated START Condition Setup Time	t_9	4700		600		160		ns
Stop Condition Setup Time	t_{10}	4000		600		160		ns
Data Hold Time	t_5	0		0		0		ns
Data Setup Time	t_8	250		100		10		ns
Clock/Data Fall Time ⁽¹⁾	t_6		300		300		160	ns
Clock/Data Rise Time	t_4		1000		300		160	ns

NOTE:

1. t_6 (MIN) for SDA output is 20ns for normal/fast mode and 10ns for high-speed mode. Glitch filter capability is 50ns for normal/fast mode and 10ns for high-speed mode.

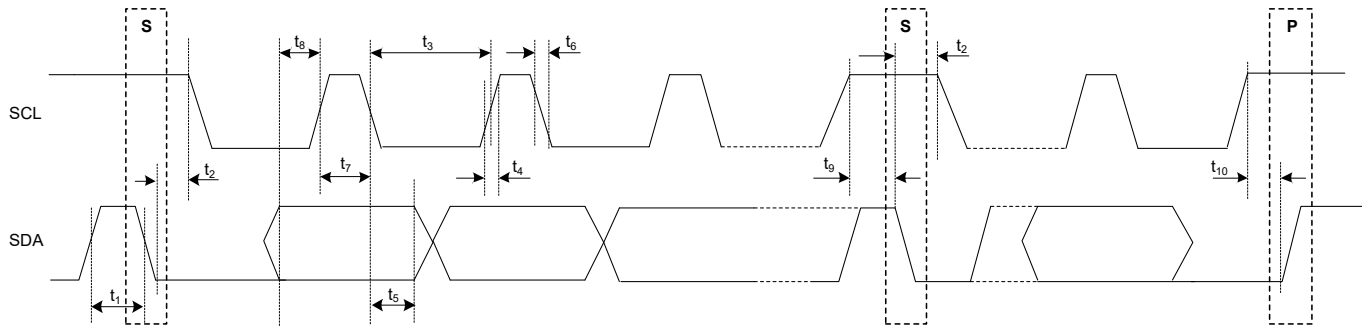
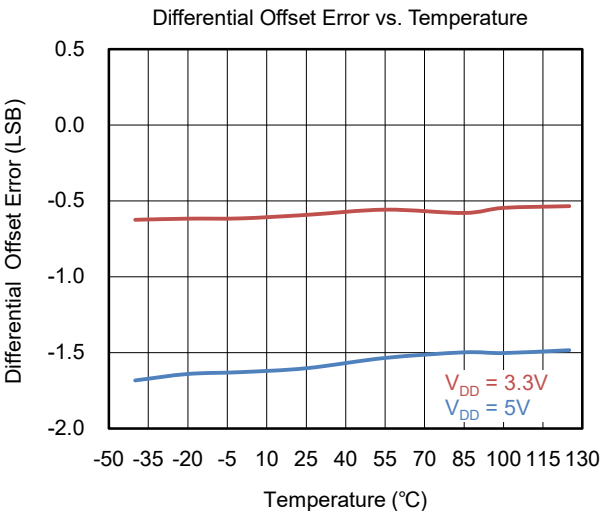
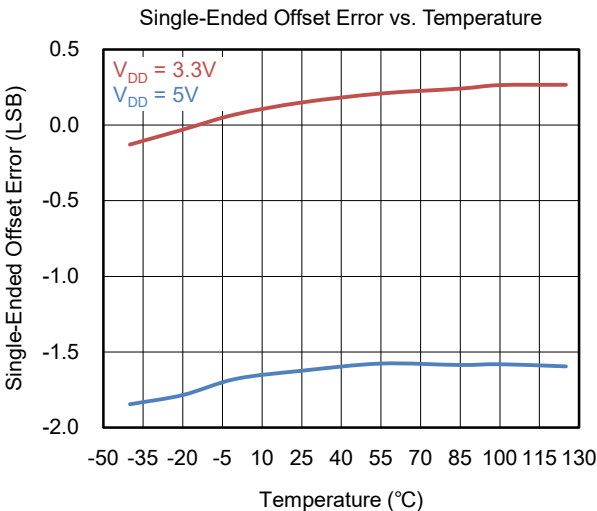
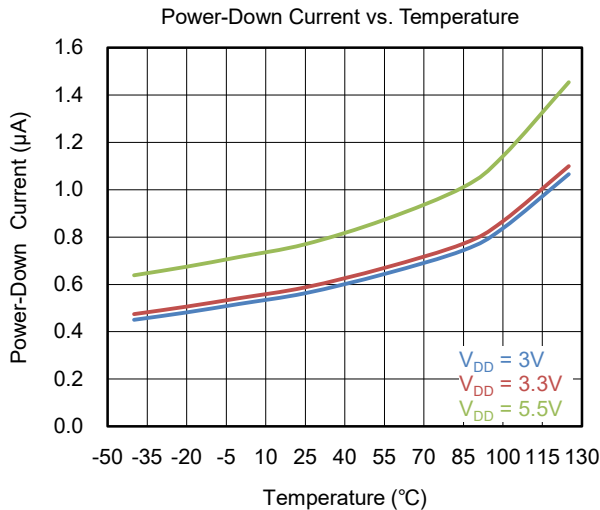
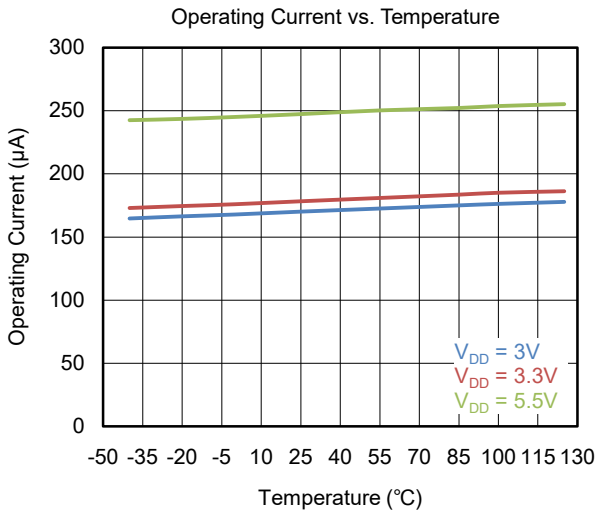
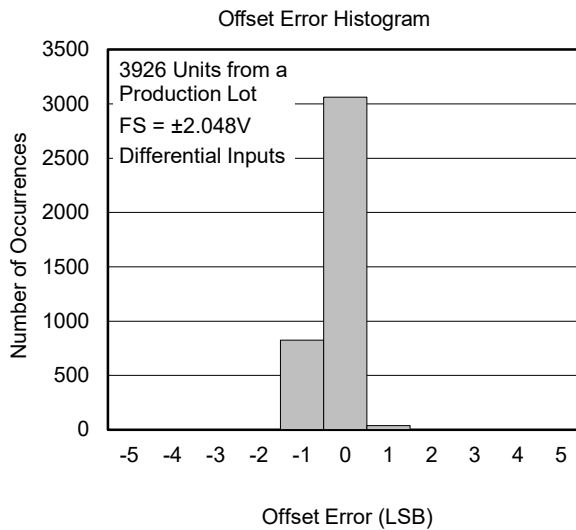
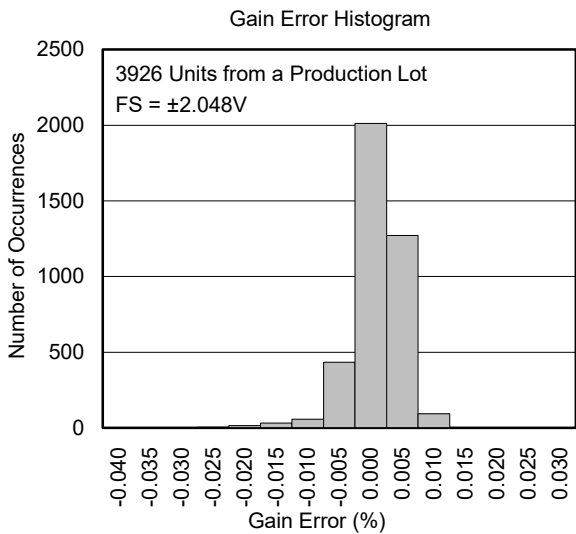

Figure 1. I²C Timing Diagram

Ultra-Small, Low-Power, 16-Bit SGM58031Q Analog-to-Digital Converter with Internal Reference

TYPICAL PERFORMANCE CHARACTERISTICS

$T_A = +25^\circ\text{C}$, $V_{DD} = 3.3\text{V}$, Data Rate = 200SPS and Full-Scale (FS) = $\pm 2.048\text{V}$, unless otherwise noted.



SGM58031Q Ultra-Small, Low-Power, 16-Bit Analog-to-Digital Converter with Internal Reference

TYPICAL PERFORMANCE CHARACTERISTICS (continued)

$T_A = +25^\circ\text{C}$, $V_{DD} = 3.3\text{V}$, Data Rate = 200SPS and Full-Scale (FS) = $\pm 2.048\text{V}$, unless otherwise noted.

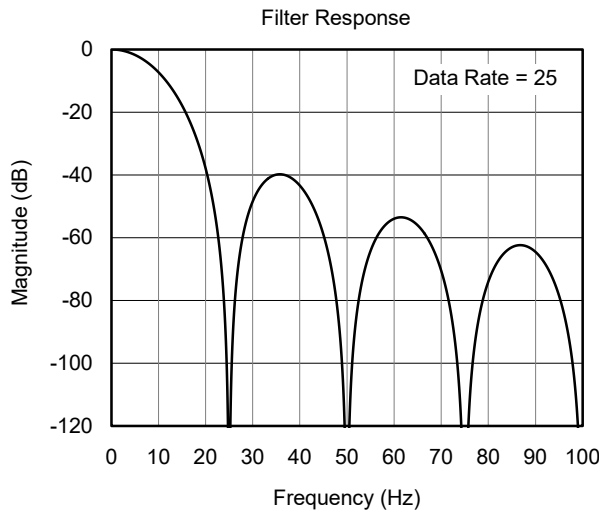
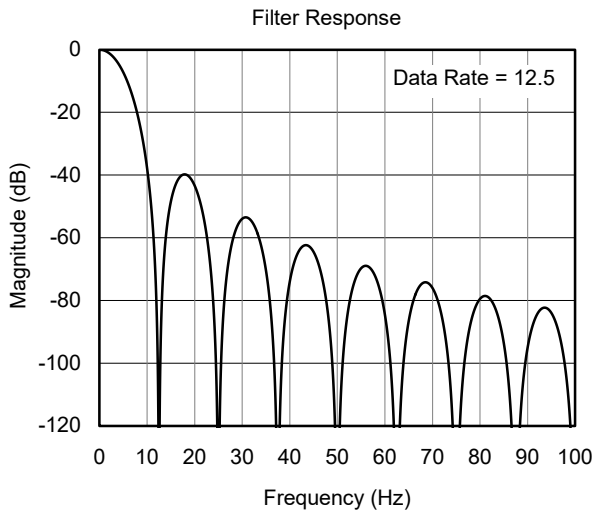
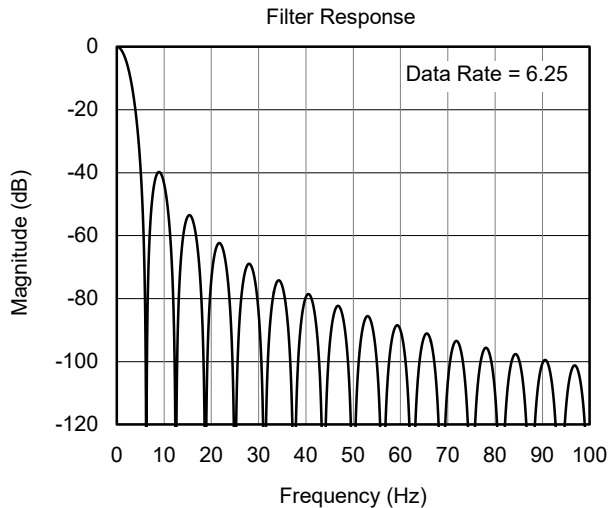
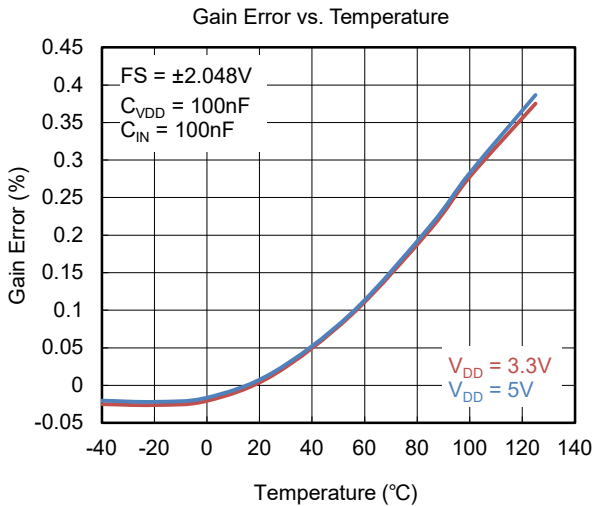
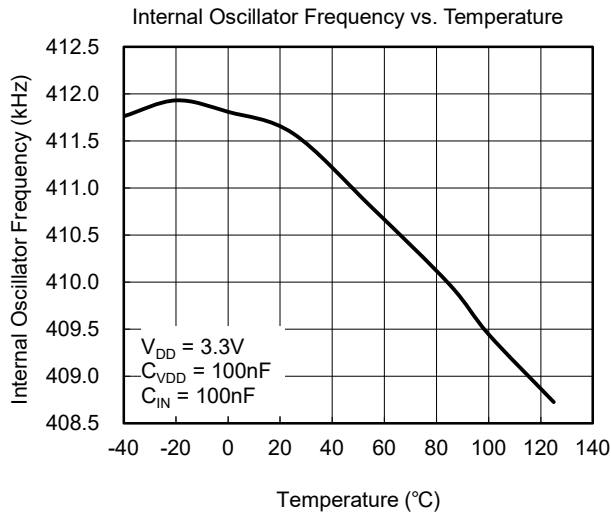
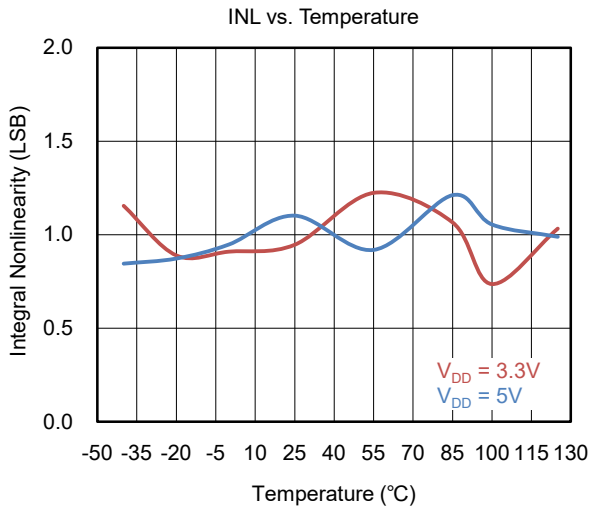

SGM58031Q Ultra-Small, Low-Power, 16-Bit Analog-to-Digital Converter with Internal Reference

TYPICAL PERFORMANCE CHARACTERISTICS (continued)

$T_A = +25^\circ\text{C}$, $V_{DD} = 3.3\text{V}$, Data Rate = 200SPS and Full-Scale (FS) = $\pm 2.048\text{V}$, unless otherwise noted.

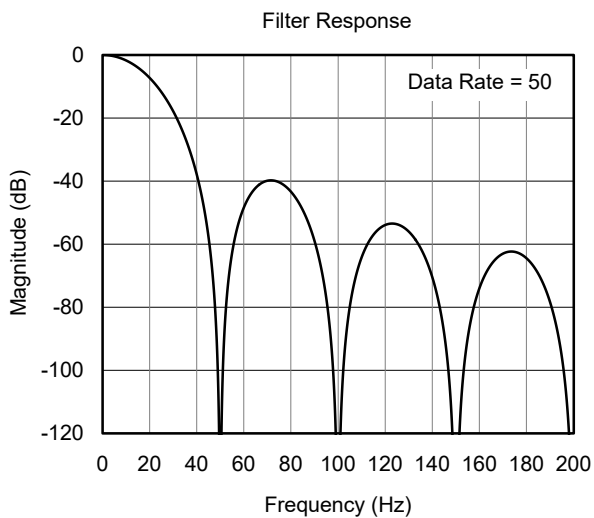

SGM58031Q Ultra-Small, Low-Power, 16-Bit Analog-to-Digital Converter with Internal Reference

FUNCTIONAL BLOCK DIAGRAM

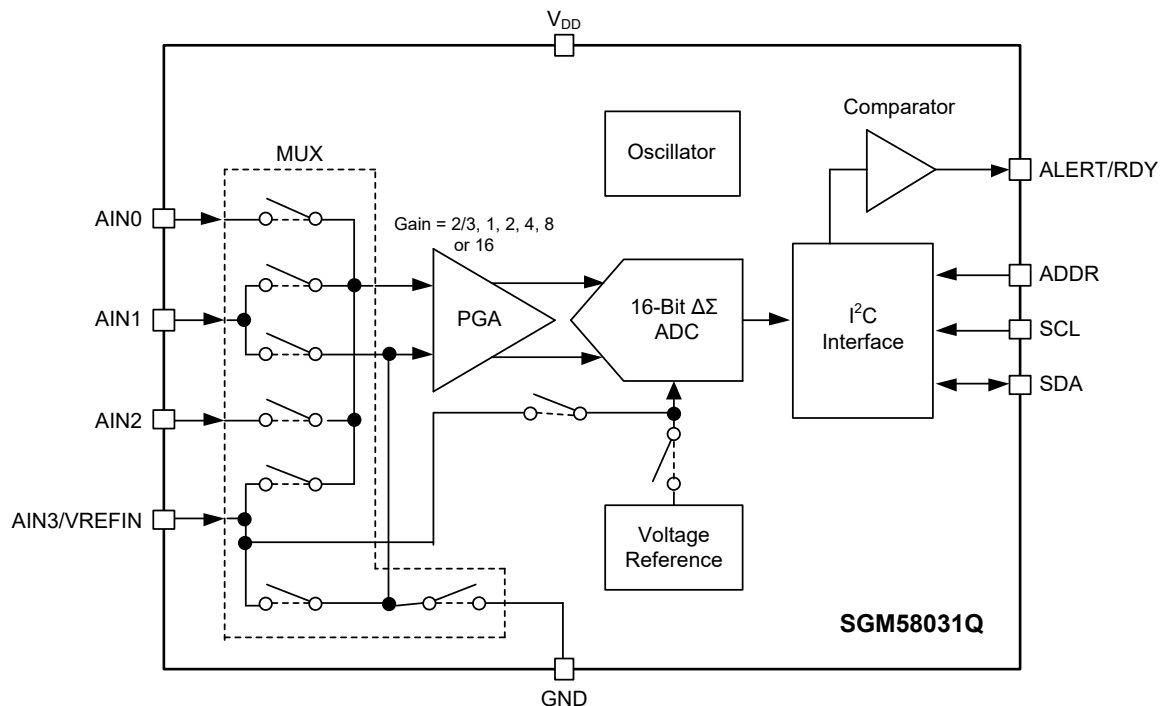

Figure 2. Functional Block Diagram

DETAILED DESCRIPTION

Overview

The SGM58031Q is a low-power, 16-bit, delta-sigma ($\Delta\Sigma$) analog-to-digital converter (ADC).

The SGM58031Q supports both differential inputs and single-ended inputs.

The SGM58031Q has two working modes: single-shot mode and continuous conversion mode.

In single-shot mode, the ADC performs one conversion and gives full settled data, while no data needs to be discarded. Once ADC completes the conversion, it then goes to low-power shutdown mode.

In continuous modes, the ADC begins a new conversion automatically after a previous conversion is completed. Every conversion result is given out. The data rate is equal to the configured data rate.

Quickstart Guide

The basic connection of ADC is shown in Figure 3. The communication interface is I²C compatible. The SGM58031Q works in slave mode. The I²C address is configured as 0b1001000 (ADDR is connected to GND).

Figure 4 and Figure 5 show the demo read and write operation sequences.

For example, writing to the configuration register 0x01 sets the SGM58031Q to continuous conversion mode following the order below:

1. First byte, 0b1001000 (first 7-bit is I²C address), the 8th bit is read/write bit which is low writing now
2. Second byte, 0b00000001 (points to Config register 0x01)
3. Third byte, 0b10000100 (MSB of the Config register to be written, Bit[8] = 0 means the continuous mode)
4. Fourth byte, 0b10000011 (LSB of the Config register to be written, Bit[7:5] = '100' means data rate 100Hz)

For example, to read the conversion result from SGM58031Q, the following order can be followed:

1. First byte, 0b1001000 (first 7-bit is I²C address), the 8th bit is read/write bit which is low writing now
2. Second byte, 0b00000000 (points to Conversion register 0x00)
3. Third byte, 0b10010001 (first 7-bit is I²C address), the 8th bit is read/write bit which is high reading now
4. Fourth byte, the SGM58031Q answers with the MSB of the Conversion register
5. Fifth byte, the SGM58031Q answers with the LSB of the Conversion register

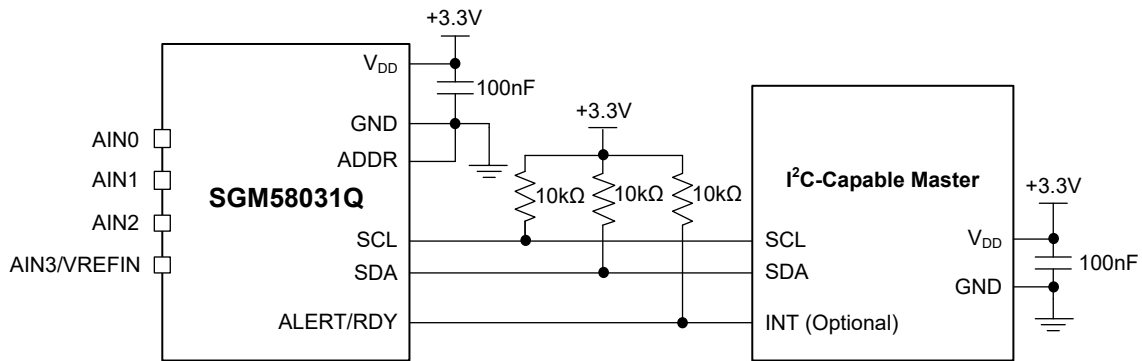
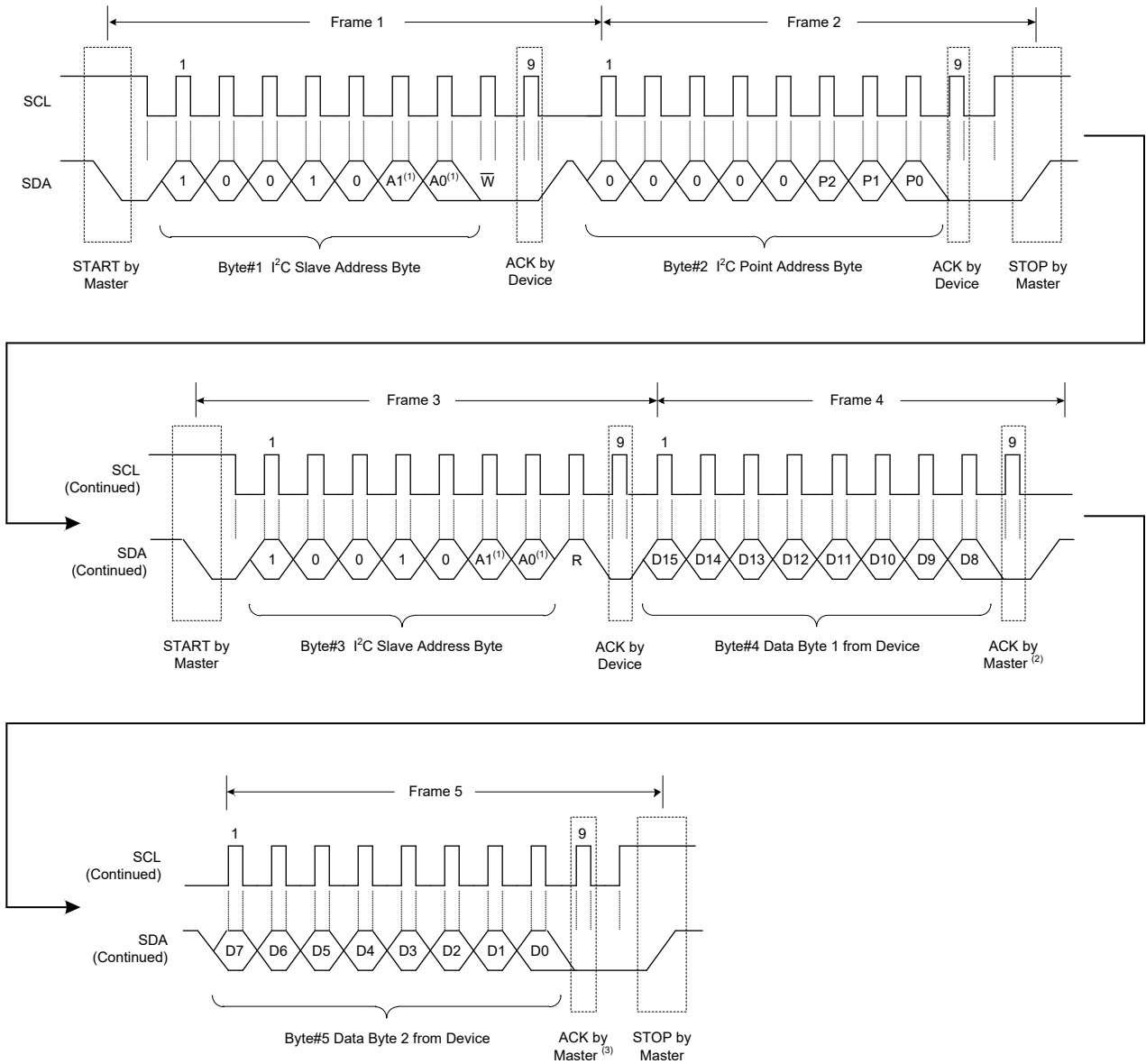

Figure 3. Basic Hardware Configuration

DETAILED DESCRIPTION (continued)



- NOTES:
1. The A0 and A1 values depend on the ADDR pin.
 2. SDA can be set high by master to terminate a single-byte read operation.
 3. SDA can be set high by master to terminate a two-byte read operation.

Figure 4. Timing Diagram for Read Word Register

DETAILED DESCRIPTION (continued)

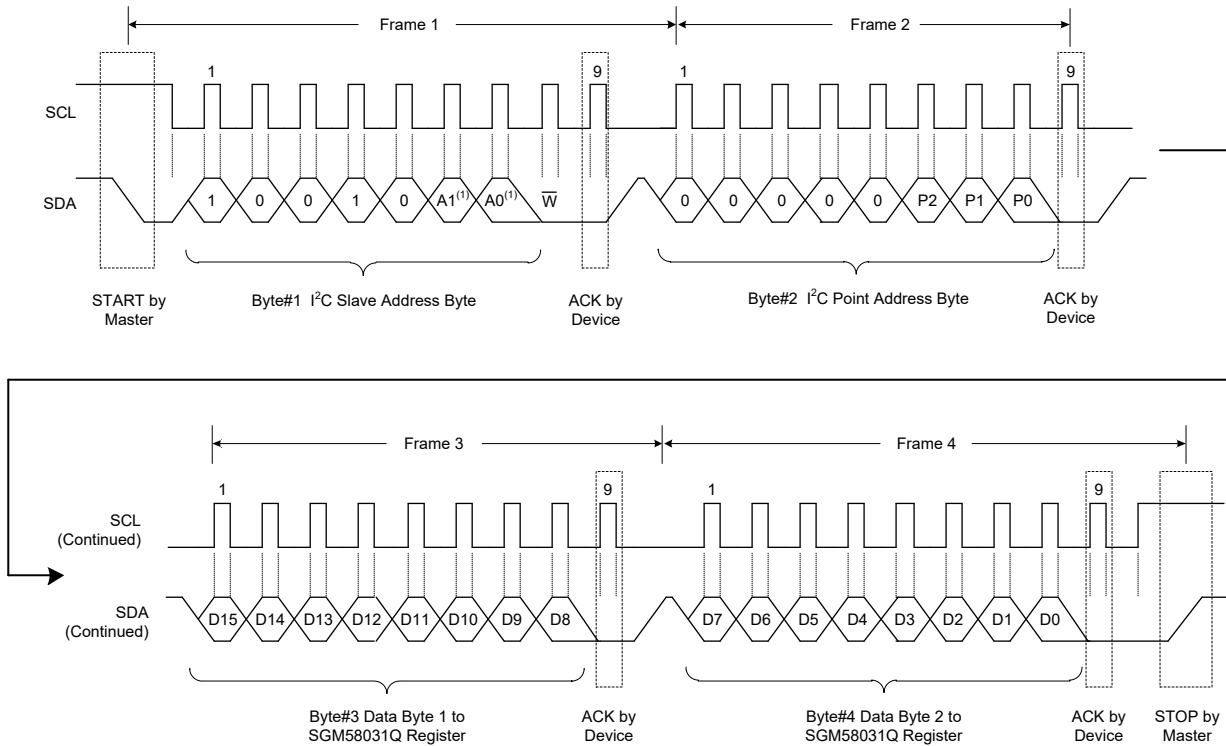

NOTE:
1. The A0 and A1 values depend on the ADDR pin.

Figure 5. Timing Diagram for Write Word Register

Multiplexer

The SGM58031Q has a flexible input multiplexer. It can be configured as 2 differential inputs or 4 single-ended inputs.

Whether the input is configured as differential inputs or single-ended inputs, the absolute voltage on any inputs pin must be in the range from GND to V_{DD} .

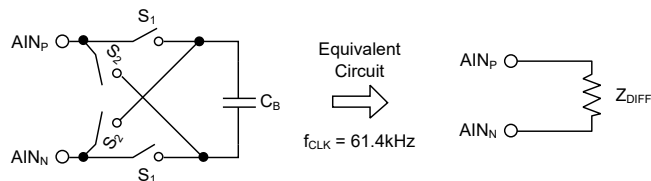

Figure 6. Simplified Analog Input Circuit

Analog Inputs

The SGM58031Q has a switched capacitor input stage. There are charge and discharge current when ADC is working. The equal effective input impedance can be estimated by $R_{EFF} = V_{IN}/I_{AVERAGE}$.

The differential input impedance is Z_{DIFF} in Figure 6. Table 1 shows the typical differential input impedance.

Table 1. Differential Input Impedance

FS (V)	Differential Input Impedance
$\pm 6.144V^{(1)}$	37.5M Ω
$\pm 4.096V^{(1)}$	25M Ω
$\pm 2.048V$	12.5M Ω
$\pm 1.024V$	6.25M Ω
$\pm 0.512V$	6.25M Ω
$\pm 0.256V$	6.25M Ω

NOTE:
1. FS = Full-scale range of the ADC scaling. In any event, the voltage applied to this device should not exceed $V_{DD} + 0.3V$.

DETAILED DESCRIPTION (continued)

Full-Scale Input

The SGM58031Q has an internal PGA. The PGA can be set to gains of 2/3, 1, 2, 4, 8 or 16. Table 2 and Table 3 show the corresponding full-scale (FS) ranges.

Analog input voltages can never exceed the analog input voltage limits.

Table 2. PGA Gain Full-Scale Range with Internal Reference

PGA Setting	FS (V)
2/3	$\pm 6.144V^{(1)}$
1	$\pm 4.096V^{(1)}$
2	$\pm 2.048V$
4	$\pm 1.024V$
8	$\pm 0.512V$
16	$\pm 0.256V$

NOTE:

1. FS = Full-scale range of the ADC scaling. In any event, the voltage applied to this device should not exceed $V_{DD} + 0.3V$.

Table 3. PGA Gain Full-Scale Range with External Reference

PGA Setting	FS (V)
2/3	$\pm 3 \times V_{REF}$
1	$\pm 2 \times V_{REF}$
2	$\pm V_{REF}$
4	$\pm V_{REF}/2$
8	$\pm V_{REF}/4$
16	$\pm V_{REF}/8$

Data Format

The SGM58031Q conversion result data is in binary two's complement format.

Table 4 shows the ideal output codes for different input signals.

Table 4. Ideal Output Code for Different Input Signals

Input Signal V_{IN} ($A_{INP} - A_{INN}$)	Ideal Output Code ⁽¹⁾
$\geq FS (2^{15} - 1)/2^{15}$	7FFFh
$+FS/2^{15}$	0001h
0	0
$-FS/2^{15}$	FFFFh
$\leq -FS$	8000h

NOTE:

1. Except for effects of INL, noise, offset, and gain errors.

Aliasing

For some applications, an RC external filtering is recommended.

Operating Modes

The SGM58031Q has two working modes, continuous mode and single-shot mode.

In continuous mode, the ADC begins a new conversion automatically after a previous conversion is completed. Every conversion result is given out.

In single-shot mode, if OS bit is written to '1', a single-shot conversion is started, during the conversion process, the OS bit is kept '0', and the chip doesn't response to OS bit operation. If conversion data is ready, the OS bit is set to '1' and the chip goes power-down automatically, and user can write '1' to OS bit to call a single-shot conversion again.

Power-Up and Reset

When the SGM58031Q is powered up, all registers are reset to default values.

The SGM58031Q supports I²C general call reset command. Refer to I²C General Call section for more details.

Duty Cycling for Low Power

In some power sensitive application, the SGM58031Q can work in sampling and power-down mode periodically. The duty cycle of working time and power-down time can be controlled by microcontroller flexibly.

For example, if the SGM58031Q is configured as sample data rate at 960Hz, it can be operated with 125ms duty cycle. This means that the chip needs to do single-shot conversion every 125ms, it will take the chip 3.2ms for sampling and then stay in power-down mode for 121.8ms. Under this working mode, it will reduce 39/40 power consumption compare with 960Hz operation in continuous mode.

DETAILED DESCRIPTION (continued)

Data Rate

Table 5. ADC Output Data Rate (SPS)

DR[2:0] Bits in Config Register	DR_SEL Bit in Config1 Register	
	DR_SEL = 0	DR_SEL = 1
000	6.25Hz	7.5Hz
001	12.5Hz	15Hz
010	25Hz	30Hz
011	50Hz	60Hz
100	100Hz	120Hz
101	200Hz	240Hz
110	400Hz	480Hz
111	800Hz	960Hz

Comparator

The SGM58031Q has an inside comparator that can be used to check ADC conversion results with high threshold and low threshold. When the result exceeds the limited setting, the chip can give an alert on the ALERT/RDY pin.

The comparator has two working modes: traditional mode and window comparator mode. These modes are configurable. Under both working modes, the comparator can be configured as latch output or no-latch output (COMP_LAT bit in Config register). In latch output mode, the latched comparator output can be cleared by issuing an SMBus alert response or by reading the Conversion register. The ALERT/RDY pin output active polarity (low or high) can be configured by COMP_POL bit in Config register. Demos are shown in Figure 7 and Figure 8.

The comparator output trigger waiting times can be set by COMP_QUE[1:0] in Config register. It means comparator output can wait until the ADC results beyond the threshold configured times (which can be one, two, or four times). Refer to Config Register section for more details.

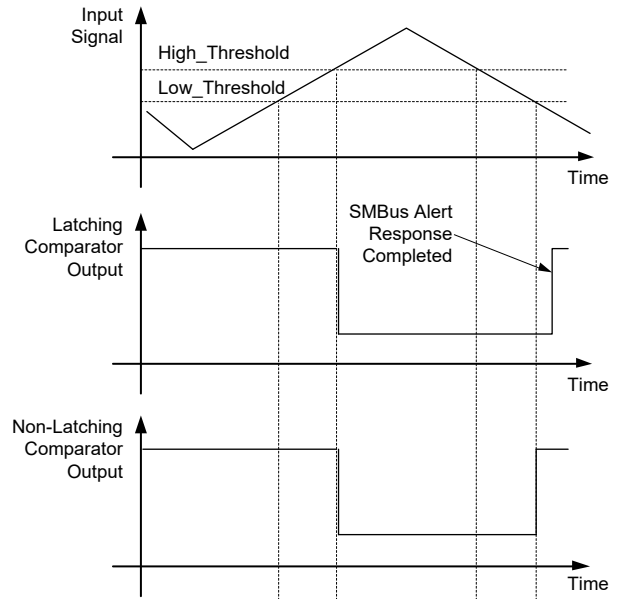

Figure 7. Alert Pin Timing Diagram when Configured as a Traditional Comparator

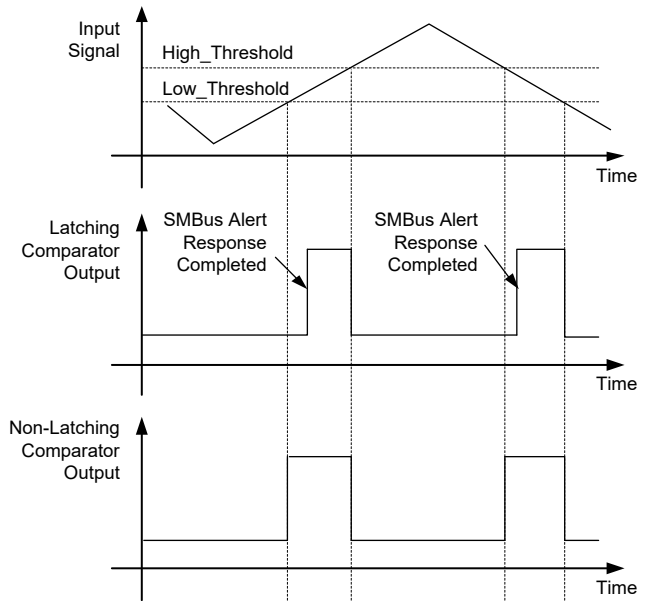

Figure 8. Alert Pin Timing Diagram when Configured as a Window Comparator

DETAILED DESCRIPTION (continued)

ADC Noise

Table 6. ADC Noise with Internal Reference (RMS in μV)

DR FS	800	400	200	100	50	25	12.5	6.25
6.144	187.5	187.5	187.5	187.5	187.5	187.5	187.5	187.5
4.096	125	125	125	125	125	125	125	125
2.048	62.5	62.5	62.5	62.5	62.5	62.5	62.5	62.5
1.024	31.25	31.25	31.25	31.25	31.25	31.25	31.25	31.25
0.512	15.62	15.62	15.62	15.62	15.62	15.62	15.62	15.62
0.256	7.81	7.81	7.81	7.81	7.81	7.81	7.81	7.81

Table 7. ADC ENOB (ENOB = $(20\log(\text{FS}/\text{Noise_RMS}) - 1.76)/6.02$)

DR FS	800	400	200	100	50	25	12.5	6.25
6.144	16	16	16	16	16	16	16	16
4.096	16	16	16	16	16	16	16	16
2.048	16	16	16	16	16	16	16	16
1.024	16	16	16	16	16	16	16	16
0.512	16	16	16	16	16	16	16	16
0.256	16	16	16	16	16	16	16	16

Conversion Ready Pin

If ALERT/RDY pin is used as a conversion ready pin, follow the operations below, firstly set the MSB (Most Significant Bit) of the high threshold register to '1', secondly set the MSB of the low threshold register to '0', and select COMP_QUE[1:0] in '00' mode. It should be noted that COMP_QUE[1:0] can disable this pin function. COMP_MODE and COMP_LAT have no effect on this function.

The ALERT/RDY pin is an open-drain output, which needs a pull-up resistor outside.

When the SGM58031Q works in continuous mode, the ALERT/RDY pin gives a pulse ($\sim 8\mu\text{s}$) at the end of every conversion completion.

When the SGM58031Q works in single-shot mode, the ALERT/RDY pin goes low (COMP_POL is set to '0') when the conversion data is ready, and keeps low until the next conversion starts. Please see demos in Figure 9 and Figure 10.

Digital Filter

The devices offer digital filter for filtering the digital data stream coming from the delta-sigma modulator. The implementation of the digital filter is determined by the ADC data rate setting. When data rate is configured as 120, 100,

60, 50, 30, 25, 15, 12.5, 7.5 and 6.25, the device uses a third-order Sinc filter (Sinc³). When data rate is configured as 200, 240, 400, 480, 800 and 960, the device uses a fourth-order Sinc filter (Sinc⁴).

When ALERT/RDY is used as the conversion completed indication pin, its default logic state is high (pulled up by the external resistor) during the conversion. When the device works in continuous mode, the ALERT/RDY pin will go low and remain low for about $8\mu\text{s}$, generating an $8\mu\text{s}$ logic low pulse at the end of each conversion cycle. When the device works in single-shot mode and the Sinc³ filter is used, the ALERT/RDY pin will go logic low after the third data conversion is finished and remain low until the device begins the next new conversion (OS bit is set to '1' again), and the ALERT/RDY pin goes logic high again during the new conversion. When the device works in single-shot mode and the Sinc⁴ filter is used, the ALERT/RDY pin will go low after the fourth data conversion is finished and remain low until the device begins the next new conversion (OS bit is set to '1' again), and the ALERT/RDY pin goes logic high again during the new conversion. Please see ALERT/RDY examples in Figure 9 and Figure 10.

DETAILED DESCRIPTION (continued)

SMBus Alert Response

The ALERT/RDY pin can output as an SMBus alert. When it is in latch mode, COMP_LAT is set to '1'. If an ADC result is above the upper threshold or below the lower threshold, this pin is set (active low or active high). And the pin output is latched, it can be cleared by reading ADC conversion data, or by issuing an SMBus alert response (reading the alerting device I²C address).

The ALERT/RDY pin is an open-drain output, which needs a pull-up resistor.

If an alert is output at the ALERT/RDY pin and latched, the master controller accepts the alert, and sends an SMBus alert

command (0b00011001) to I²C bus. Any SGM58031Q on the bus will respond with their own address. The lowest I²C address chip will occupy the bus and it will clear itself ALERT/RDY pin. The chip which loses I²C bus will keep alert on ALERT/RDY pin. The master will repeat SMBus alert command until all slave chips clear their alerts.

When ALERT/RDY pin is configured as window comparator mode, if ADC result is higher than upper threshold or ADC result is below the lower threshold, the pin is set (active low or active high).

Timing diagram for SMBus alert response is shown in Figure 11.

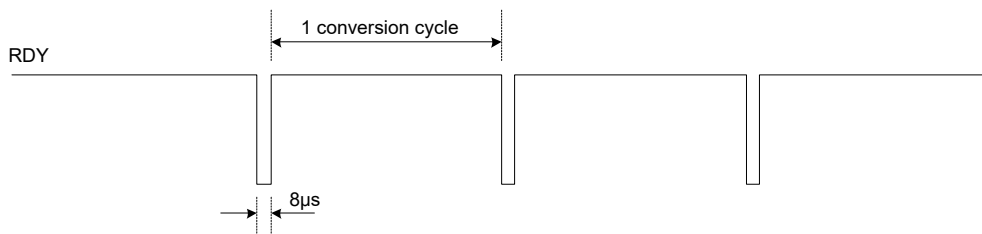

Figure 9. RDY in Continuous Mode

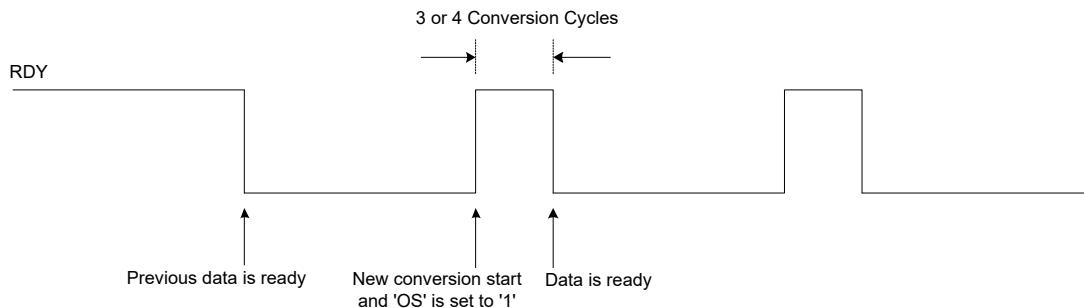
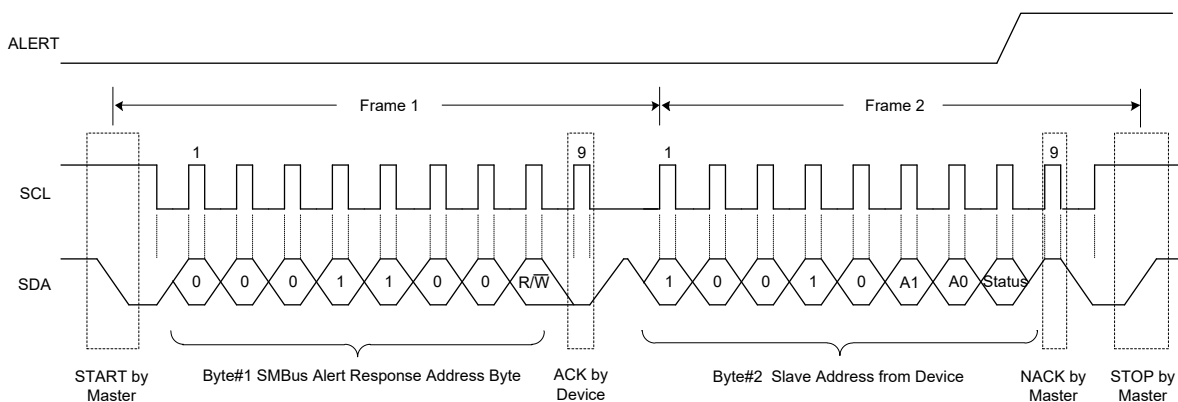

Figure 10. RDY in Single-Shot Mode



NOTE: 1. The A0 and A1 values depend on the ADDR pin.

Figure 11. Timing Diagram for SMBus Alert Response

DETAILED DESCRIPTION (continued)**I²C Interface**

The SGM58031Q communication interface is an I²C interface. The SGM58031Q can only act as slave devices. An I²C timing diagram is shown in Figure 1.

I²C Address Selection

The SGM58031Q has a separate address setting pin ADDR, which can be connected to GND, V_{DD}, SDA and SCL. Table 8 shows the four available addresses.

Table 8. ADDR Pin Connection and Corresponding Slave Address

ADDR Pin	Slave Address
GND	1001000
V _{DD}	1001001
SDA	1001010
SCL	1001011

I²C General Call

The SGM58031Q supports I²C general call address (0000000) and the eighth bit must be '0'. The device acknowledges the general call address. And if the second byte is 00000110 (06h), the SGM58031Q resets all registers and goes to power-down.

I²C Speed Modes

The I²C bus operation supports three speed modes: Standard mode, fast mode, and high-speed mode. See more details in Electrical Characteristics section.

To enter standard and fast mode, no special operation is needed.

To enter high-speed mode, send a special address byte of 00001XXX following the I²C start condition. The SGM58031Q doesn't give an ACK (acknowledge) to this byte, and the SGM58031Q switches to high-speed mode after receiving this byte. The SGM58031Q quits high-speed mode with the next STOP condition.

Slave Mode Operations

The SGM58031Q works in slave mode and doesn't drive the SCL line.

REGISTER MAPS

Register Address

The SGM58031Q has seven pointer registers. Table 9 and Table 10 shows these register maps. Figure 4 shows how to access this pointer registers.

Table 9. Register Address

Address	Register
0x0	Conversion Register
0x1	Config Register
0x2	Low_Thresh Register
0x3	High_Thresh Register
0x4	Config1 Register
0x5	Chip_ID Register
0x6	GN_Trim1 Register for EXT_REF

Pointer Register

Table 10. Pointer Register Byte (Write-Only)

MSB							LSB
Bit 7	Bit 6	Bit 5	Bit 4	Bit 3	Bit 2	Bit 1	Bit 0
0	0	0	0	0	Register Address		

Conversion Register

The ADC conversion result is 16-bit two's complement format. Table 11 shows the data format. Its reset default value is '0'.

Table 11. 16-Bit Conversion Register (Read-Only)

MSB															LSB
Bit 15	Bit 14	Bit 13	Bit 12	Bit 11	Bit 10	Bit 9	Bit 8	Bit 7	Bit 6	Bit 5	Bit 4	Bit 3	Bit 2	Bit 1	Bit 0
D15	D14	D13	D12	D11	D10	D9	D8	D7	D6	D5	D4	D3	D2	D1	D0

NOTE: Default Value = 0000h.

REGISTER MAPS (continued)

Config Register

The configuration register (Config Register) is shown in Table 12.

Table 12. Config Register Details (Read/Write)

BITS	NAME	DESCRIPTION	COMMENT	DEFAULT VALUE
D[15]	OS	Working Status/Single-Shot Conversion Start For a write status: 0 = No effect 1 = Start a single conversion (when in single-shot mode) For a read status: 0 = The chip is doing a conversion 1 = The chip isn't doing a conversion	This bit reports the status of the chip. This bit can only be written when the chip is in power-down.	
D[14:12]	MUX[2:0]	Input Multiplexer (MUX) Configuration 000 = AIN _P = AIN0 and AIN _N = AIN1 (default) 001 = AIN _P = AIN0 and AIN _N = AIN3 010 = AIN _P = AIN1 and AIN _N = AIN3 011 = AIN _P = AIN2 and AIN _N = AIN3 100 = AIN _P = AIN0 and AIN _N = GND 101 = AIN _P = AIN1 and AIN _N = GND 110 = AIN _P = AIN2 and AIN _N = GND 111 = AIN _P = AIN3 and AIN _N = GND		000
D[11:9]	PGA[2:0]	Programmable Gain Amplifier (PGA) Configuration 000 = FS = ±6.144V ⁽¹⁾ 001 = FS = ±4.096V ⁽¹⁾ 010 = FS = ±2.048V (default) 011 = FS = ±1.024V 100 = FS = ±0.512V 101 = FS = ±0.256V 110 = FS = ±0.256V 111 = FS = ±0.256V		010
D[8]	MODE	Device Operating Mode 0 = Continuous conversion mode 1 = Power-down single-shot mode (default)		1
D[7:5]	DR[2:0]	Data Rate	These bits control the data rate setting. See Table 5.	100
D[4]	COMP_MODE	Comparator Mode 0 = A traditional comparator with hysteresis (default) 1 = A window comparator		0
D[3]	COMP_POL	Comparator Polarity 0 = Active low (default) 1 = Active high	This bit sets the active polarity of the ALERT/RDY pin.	0
D[2]	COMP_LAT	Latching Comparator 0 = Non-latching comparator (default) 1 = Latching comparator	This bit sets whether the ALERT/RDY pin latches once its outputs are set or reset when ADC conversion result is within the upper and lower threshold limitations.	0
D[1:0]	COMP_QUE[1:0]	Comparator Queue and Disable Function 00 = Assert after one conversion 01 = Assert after two conversions 10 = Assert after four conversions 11 = Disable comparator (default)	These bits can disable the comparator. These bits can set the required times of successive ADC conversion beyond the threshold before an alert output on ALERT/RDY pin.	11

NOTES:

1. Default Value = 8583h.
2. This is a theoretical full-scale range of the ADC scaling. The real input must be within the electrical limitation (0V ~ V_{DD} + 0.3V).

REGISTER MAPS (continued)

Low_Thresh and High_Thresh Registers

The lower (Low_Thresh) and upper (High_Thresh) threshold registers are in 16-bit two's complement format. Table 13 shows these two register format.

Table 13. Low_Thresh and High_Thresh Registers (Read/Write)

Low_Thresh Register							
Bit 15	Bit 14	Bit 13	Bit 12	Bit 11	Bit 10	Bit 9	Bit 8
Low_Thresh[15:8]							
Bit 7	Bit 6	Bit 5	Bit 4	Bit 3	Bit 2	Bit 1	Bit 0
Low_Thresh[7:0]							
High_Thresh Register							
Bit 15	Bit 14	Bit 13	Bit 12	Bit 11	Bit 10	Bit 9	Bit 8
High_Thresh[15:8]							
Bit 7	Bit 6	Bit 5	Bit 4	Bit 3	Bit 2	Bit 1	Bit 0
High_Thresh[7:0]							

NOTE: Low_Thresh Default Value = 8000h, High_Thresh Default Value = 7FFFh.

Config1 Register

Table 14. 16-Bit Config1 Register Details

BITS	NAME	DESCRIPTION	COMMENT	DEFAULT VALUE
D[15:9]	N/A			
D[8]	PD	Writing '1' to PD powers down this part, and this PD bit is automatically cleared internally. Another continuous/single conversion can be carried out again without the need to clear this bit.		0
D[7]	DR_SEL	0 = DR[2:0] = 000 ~ 111 for conversion rate of 6.25Hz, 12.5Hz, 25Hz, 50Hz, 100Hz, 200Hz, 400Hz and 800Hz (default) 1 = DR[2:0] = 000 ~ 111 for conversion rate of 7.5Hz, 15Hz, 30Hz, 60Hz, 120Hz, 240Hz, 480Hz and 960Hz		0
D[6]	BURNOUT	0 = No current sourced (default) 1 = Source a pair of 2μA current to selected pair of AINs		0
D[5:4]	Reserved			
D[3]	EXT_REF	0 = None (default) 1 = Use AIN3 as external reference for ADC		0
D[2:0]	N/A			

REGISTER MAPS (continued)

Chip_ID Register

Table 15. 16-Bit Chip_ID Register for Identifying Chip ID and Its Subversions (Read-Only)

Bit 15	Bit 14	Bit 13	Bit 12	Bit 11	Bit 10	Bit 9	Bit 8
N/A	N/A	N/A	ID[4:0]				
0	0	0	0	0	0	0	0
Bit 7	Bit 6	Bit 5	Bit 4	Bit 3	Bit 2	Bit 1	Bit 0
VER[2:0]			N/A	N/A	N/A	N/A	N/A
1	0	0	0	0	0	0	0

GN_Trim1 Register (When Using EXT_REF)

Select Config1 register EXT_REF bit as the referenced ADC gain coefficient for user. A default value is provided, and the user should write the proper value to the register if the external reference error needs to be compensated. This register does not take effect when EXT_REF = 0 and internal reference is selected.

Table 16. GN_Trim1 Format

Bit 15	Bit 14	Bit 13	Bit 12	Bit 11	Bit 10	Bit 9	Bit 8
N/A	N/A	N/A	N/A	N/A	GN10	GN9	GN8
0	0	0	0	0	0	1	1
Bit 7	Bit 6	Bit 5	Bit 4	Bit 3	Bit 2	Bit 1	Bit 0
GN7	GN6	GN5	GN4	GN3	GN2	GN1	GN0
1	1	1	1	1	0	1	0

ADC GN_Trim1 register is an unsigned value. Default value used for final trimming is 1.3333 to compensate default ADC gain of 3/4. The value of GN[10:0] adds a constant to get the final gain trimming value.

$GN_Trim1 + CONST = GN_Trim$. The binary value of CONST is 1010011010110000, corresponding to a gain factor of 1.30225. After adding the default value of GN_Trim1 register (01111111010), the final default gain trimming value is 1.3333. The MAX final gain trimming value is 1.3547 when trimming register is all '1'. MIN value is 1.30225 when register is all '0'. This gives GN trimming a $\pm 3\%$ range and 32ppmFS step.

PACKAGE OUTLINE DIMENSIONS

MSOP-10

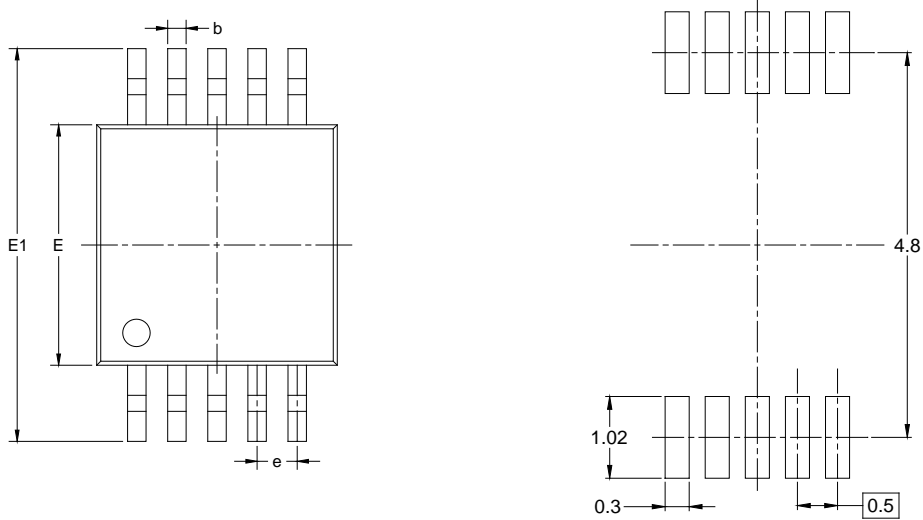

RECOMMENDED LAND PATTERN (Unit: mm)

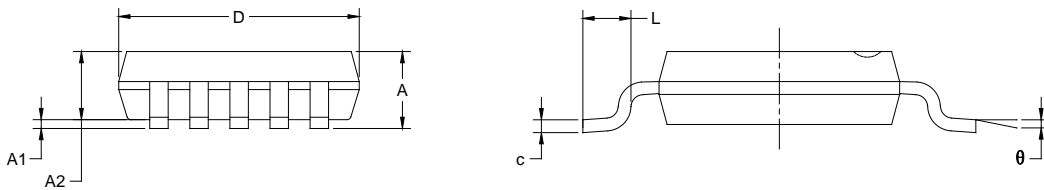

Symbol	Dimensions In Millimeters		Dimensions In Inches	
	MIN	MAX	MIN	MAX
A	0.820	1.100	0.032	0.043
A1	0.020	0.150	0.001	0.006
A2	0.750	0.950	0.030	0.037
b	0.180	0.280	0.007	0.011
c	0.090	0.230	0.004	0.009
D	2.900	3.100	0.114	0.122
E	2.900	3.100	0.114	0.122
E1	4.750	5.050	0.187	0.199
e	0.500 BSC		0.020 BSC	
L	0.400	0.800	0.016	0.031
θ	0°	6°	0°	6°

NOTES:

1. Body dimensions do not include mode flash or protrusion.
2. This drawing is subject to change without notice.

PACKAGE INFORMATION

TAPE AND REEL INFORMATION

REEL DIMENSIONS

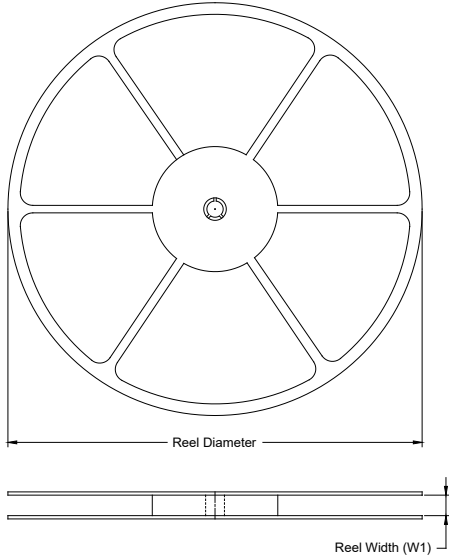

TAPE DIMENSIONS

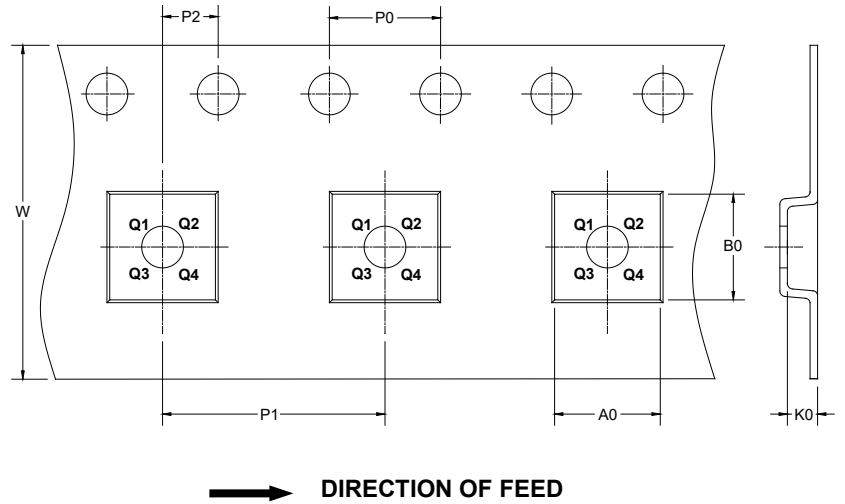

NOTE: The picture is only for reference. Please make the object as the standard.

KEY PARAMETER LIST OF TAPE AND REEL

Package Type	Reel Diameter	Reel Width W1 (mm)	A0 (mm)	B0 (mm)	K0 (mm)	P0 (mm)	P1 (mm)	P2 (mm)	W (mm)	Pin1 Quadrant
MSOP-10	13"	12.4	5.20	3.30	1.50	4.0	8.0	2.0	12.0	Q1

000001

PACKAGE INFORMATION

CARTON BOX DIMENSIONS



NOTE: The picture is only for reference. Please make the object as the standard.

KEY PARAMETER LIST OF CARTON BOX

Reel Type	Length (mm)	Width (mm)	Height (mm)	Pizza/Carton
13"	386	280	370	5

DD0002