

# TPS6216x-Q1 3-V to 17-V 1-A Step-Down Converter with DCS-Control™

## 1 Features

- DCS-Control™ topology
- Qualified for automotive applications
- AEC-Q100 qualified with the following results:
  - Device temperature grade: –40°C to 125°C operating junction temperature range
  - Device HBM ESD classification level H2
  - Device CDM ESD classification level C4B
- [Functional Safety-Capable](#)
  - Documentation available to aid functional safety system design
- Input voltage range: 3 V to 17 V
- Up to 1-A output current
- Adjustable output voltage from 0.9 V to 6 V
- Fixed output voltage versions
- Seamless power save mode transition
- Typically 17-µA quiescent current
- Power-good output
- 100% Duty cycle mode
- Short circuit protection
- Overtemperature protection
- Pin-to-pin compatible with [TPS62170-Q1](#)
- Available in a 2-mm x 2-mm WSON-8 package

## 2 Applications

- [ADAS camera](#)
- [Infotainment telematics](#)
- [Body control module and gateway](#)
- [Powertrain systems](#)

## 3 Description

The TPS6216x-Q1 are easy to use synchronous step down DC-DC converters optimized for applications with high power density. A high switching frequency of typically 2.25 MHz allows the use of small inductors and provides fast transient response as well as high output voltage accuracy by using the DCS-Control™ topology.

With their wide operating input voltage range of 3 V to 17 V, the devices are ideally suited for systems powered from either a Li-Ion or other battery as well as from 12-V intermediate power rails. It supports up to 1-A continuous output current at output voltages between 0.9 V and 6 V (with 100% duty cycle mode).

Power sequencing is also possible by configuring the Enable and open-drain Power Good pins.

In Power Save Mode, the devices draw quiescent current of about 17 µA from VIN. Power Save Mode, entered automatically and seamlessly if load is small, maintains high efficiency over the entire load range. In Shutdown Mode, the device is turned off and shutdown current consumption is less than 2 µA.

The devices are available in adjustable and fixed output voltage versions and are packaged in an 8-pin WSON package measuring 2 x 2 mm (DSG).

### Device Information<sup>(1)</sup>

PART NUMBER	PACKAGE	BODY SIZE (NOM)
TPS62160-Q1	WSON (8)	2.00 mm x 2.00 mm
TPS62162-Q1	WSON (8)	2.00 mm x 2.00 mm

(1) For all available packages, see the orderable addendum at the end of the datasheet.

### Simplified Schematic

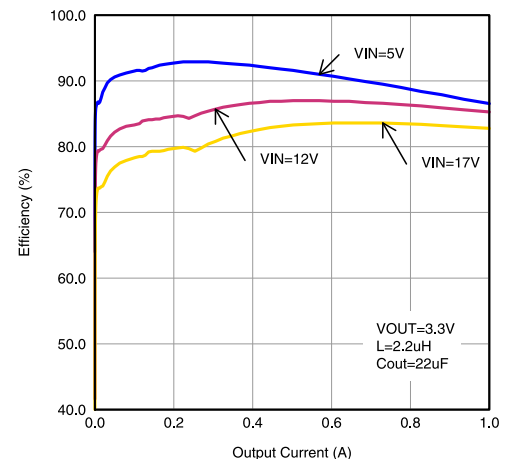
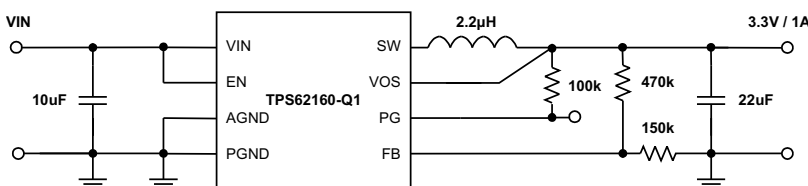

## Table of Contents

<b>1</b>	<b>Features</b> .....	<b>1</b>	9.1	Application Information.....	<b>11</b>
<b>2</b>	<b>Applications</b> .....	<b>1</b>	9.2	Typical TPS62160-Q1 Application .....	<b>11</b>
<b>3</b>	<b>Description</b> .....	<b>1</b>	9.3	System Examples .....	<b>19</b>
<b>4</b>	<b>Revision History</b> .....	<b>2</b>	<b>10</b>	<b>Power Supply Recommendations</b> .....	<b>21</b>
<b>5</b>	<b>Device Comparison Table</b> .....	<b>3</b>	<b>11</b>	<b>Layout</b> .....	<b>22</b>
<b>6</b>	<b>Pin Configuration and Functions</b> .....	<b>3</b>	11.1	Layout Guidelines .....	<b>22</b>
<b>7</b>	<b>Specifications</b> .....	<b>4</b>	11.2	Layout Example .....	<b>22</b>
7.1	Absolute Maximum Ratings .....	<b>4</b>	11.3	Thermal Considerations .....	<b>23</b>
7.2	ESD Ratings.....	<b>4</b>	<b>12</b>	<b>Device and Documentation Support</b> .....	<b>24</b>
7.3	Recommended Operating Conditions .....	<b>4</b>	12.1	Device Support .....	<b>24</b>
7.4	Thermal Information .....	<b>4</b>	12.2	Documentation Support .....	<b>24</b>
7.5	Electrical Characteristics.....	<b>5</b>	12.3	Related Links .....	<b>24</b>
7.6	Typical Characteristics .....	<b>6</b>	12.4	Receiving Notification of Documentation Updates .....	<b>24</b>
<b>8</b>	<b>Detailed Description</b> .....	<b>7</b>	12.5	Support Resources .....	<b>24</b>
8.1	Overview .....	<b>7</b>	12.6	Trademarks .....	<b>24</b>
8.2	Functional Block Diagram .....	<b>7</b>	12.7	Electrostatic Discharge Caution .....	<b>24</b>
8.3	Feature Description.....	<b>8</b>	12.8	Glossary .....	<b>25</b>
8.4	Device Functional Modes.....	<b>9</b>	<b>13</b>	<b>Mechanical, Packaging, and Orderable Information</b> .....	<b>25</b>
<b>9</b>	<b>Application and Implementation</b> .....	<b>11</b>			

## 4 Revision History

NOTE: Page numbers for previous revisions may differ from page numbers in the current version.

Changes from Revision A (November 2016) to Revision B	Page
• Added functional safety bullet in the <i>Features</i> .....	<b>1</b>

Changes from Original (December 2014) to Revision A	Page
• Added device TPS62162-Q1 .....	<b>1</b>
• Added the <i>Device Comparison Table</i> .....	<b>3</b>
• Changed the <i>Thermal Information</i> table .....	<b>4</b>
• Added Warranty disclaimer NOTE: at <i>Application and Implementation</i> section. ....	<b>11</b>
• Added <i>Related Links</i> section .....	<b>24</b>
• Added <i>Receiving Notification of Documentation Updates</i> and <i>Support Resources</i> sections.....	<b>24</b>

## 5 Device Comparison Table

PART NUMBER <sup>(1)</sup>	OUTPUT VOLTAGE
TPS62160-Q1	Adjustable
TPS62162-Q1	3.3 V

(1) For detailed ordering information please, check the [Mechanical, Packaging, and Orderable Information](#) section at the end of this datasheet.

## 6 Pin Configuration and Functions

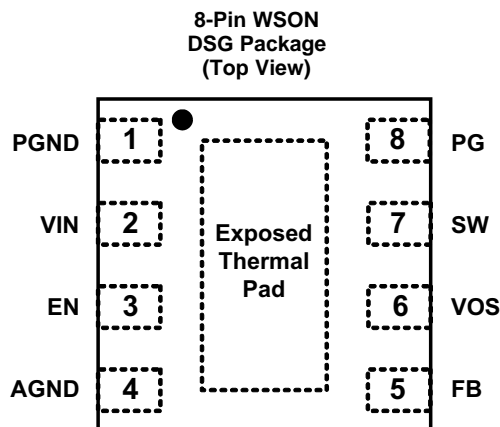

Pin Functions

PIN <sup>(1)</sup>		I/O	DESCRIPTION
NAME	NO.		
PGND	1		Power ground
VIN	2	I	Supply voltage
EN	3	I	Enable input (High = enabled, Low = disabled)
AGND	4		Analog Ground
FB	5	I	Voltage feedback of adjustable version. Connect resistive voltage divider to this pin. It is recommended to connect FB to AGND on fixed output voltage versions for improved thermal performance.
VOS	6	I	Output voltage sense pin and connection for the control loop circuitry
SW	7	O	Switch node, which is connected to the internal MOSFET switches. Connect inductor between SW and output capacitor.
PG	8	O	Output power good (High = VOUT ready, low = VOUT below nominal regulation); open drain (requires pullup resistor; goes high impedance, when device is switched off)
Exposed Thermal Pad			Must be connected to AGND. Must be soldered to achieve appropriate power dissipation and mechanical reliability.

(1) For more information about connecting pins, see [Detailed Description](#) and [Application Information](#) sections.

## 7 Specifications

### 7.1 Absolute Maximum Ratings

over operating junction temperature range (unless otherwise noted)<sup>(1)</sup>

		MIN	MAX	UNIT
Pin voltage range <sup>(2)</sup>	V <sub>IN</sub>	-0.3	20	V
	EN, SW	-0.3	V <sub>IN</sub> +0.3	V
	FB, PG, VOS	-0.3	7	V
Power Good sink current	PG		10	mA
Operating junction temperature range, T <sub>J</sub>		-40	150	°C
Storage temperature range, T <sub>stg</sub>		-65	150	°C

(1) Stresses beyond those listed under *absolute maximum ratings* may cause permanent damage to the device. These are stress ratings only, and functional operation of the device at these or any other conditions beyond those indicated under *recommended operating conditions* is not implied. Exposure to absolute-maximum-rated conditions for extended periods may affect device reliability.

(2) All voltages are with respect to network ground terminal.

### 7.2 ESD Ratings

			VALUE	UNIT
V <sub>(ESD)</sub>	Electrostatic discharge	Human body model (HBM), per AEC Q100-002 <sup>(1)</sup>	±2000	V
		Charged device model (CDM), per AEC Q100-011	±500	

(1) AEC Q100-002 indicates HBM stressing is done in accordance with the ANSI/ESDA/JEDEC JS-001 specification.

### 7.3 Recommended Operating Conditions

over operating junction temperature range (unless otherwise noted)

		MIN	TYP	MAX	UNIT
V <sub>IN</sub>	Supply voltage	3		17	V
V <sub>OUT</sub>	Output voltage range	0.9		6	V
T <sub>J</sub>	Operating junction temperature	-40		125	°C

### 7.4 Thermal Information

THERMAL METRIC <sup>(1)</sup>		TPS6216x-Q1	UNIT
		DSG (8 PINS)	
R <sub>θJA</sub>	Junction-to-ambient thermal resistance	65.5	°C/W
R <sub>θJC(top)</sub>	Junction-to-case (top) thermal resistance	66.4	°C/W
R <sub>θJB</sub>	Junction-to-board thermal resistance	35.5	°C/W
Ψ <sub>JT</sub>	Junction-to-top characterization parameter	1.7	°C/W
Ψ <sub>JB</sub>	Junction-to-board characterization parameter	35.8	°C/W
R <sub>θJC(bot)</sub>	Junction-to-case (bottom) thermal resistance	8.4	°C/W

(1) For more information about traditional and new thermal metrics, see the [IC Package Thermal Metrics application report](#).

## 7.5 Electrical Characteristics

Over junction temperature range ( $T_J = -40^\circ\text{C}$  to  $+125^\circ\text{C}$ ), typical values at  $V_{IN} = 12\text{ V}$  and  $T_J = 25^\circ\text{C}$  (unless otherwise noted)

PARAMETER		TEST CONDITIONS	MIN	TYP	MAX	UNIT
<b>SUPPLY</b>						
$V_{IN}$	Input voltage range <sup>(1)</sup>		3		17	V
$I_Q$	Operating quiescent current	EN = High, $I_{OUT} = 0\text{ mA}$ , Device not switching		17	30	$\mu\text{A}$
$I_{SD}$	Shutdown current <sup>(2)</sup>	EN = Low		1.8	25	$\mu\text{A}$
$V_{UVLO}$	Undervoltage lockout threshold	Falling input voltage	2.6	2.7	2.82	V
		Hysteresis		180		mV
$T_{SD}$	Thermal shutdown temperature			160		$^\circ\text{C}$
	Thermal shutdown hysteresis			20		
<b>CONTROL (EN, PG)</b>						
$V_{EN\_H}$	High level input threshold voltage (EN)		0.9			V
$V_{EN\_L}$	Low level input threshold voltage (EN)				0.3	V
$I_{LKG\_EN}$	Input leakage current (EN)	EN = $V_{IN}$ or GND		0.01	1	$\mu\text{A}$
$V_{TH\_PG}$	Power Good threshold voltage	Rising ( $\%V_{OUT}$ )	92%	95%	98%	
		Falling ( $\%V_{OUT}$ )	87%	90%	93%	
$V_{OL\_PG}$	Power Good output low	$I_{PG} = -2\text{ mA}$		0.07	0.3	V
$I_{LKG\_PG}$	Input leakage current (PG)	$V_{PG} = 1.8\text{ V}$		1	400	nA
<b>POWER SWITCH</b>						
$R_{DS(ON)}$	High-side MOSFET ON-resistance	$V_{IN} \geq 6\text{ V}$		300	600	m $\Omega$
		$V_{IN} = 3\text{ V}$		430		
	Low-side MOSFET ON-resistance	$V_{IN} \geq 6\text{ V}$		120	200	m $\Omega$
		$V_{IN} = 3\text{ V}$		165		
$I_{LIMF}$	High-side MOSFET forward current limit <sup>(3)</sup>	$V_{IN} = 12\text{ V}$ , $T_A = 25^\circ\text{C}$	1.45	1.95	2.45	A
<b>OUTPUT</b>						
$V_{REF}$	Internal reference voltage			0.8		V
$I_{LKG\_FB}$	Pin leakage current (FB)	$V_{FB} = 1.2\text{ V}$		5	400	nA
$V_{OUT}$	Output voltage range (TPS62160-Q1)	$V_{IN} \geq V_{OUT}$	0.9		6.0	V
	Feedback voltage accuracy <sup>(4)</sup>	PWM Mode operation, $V_{IN} \geq V_{OUT} + 1\text{ V}$	-3%		3%	
		Power Save Mode operation, $C_{OUT} = 2 \times 22\ \mu\text{F}$ <sup>(5)</sup>	-3%		4%	
	DC output voltage load regulation <sup>(6)</sup>	$V_{IN} = 12\text{ V}$ , $V_{OUT} = 3.3\text{ V}$ , PWM Mode operation		0.05		
DC output voltage line regulation <sup>(6)</sup>	$3\text{ V} \leq V_{IN} \leq 17\text{ V}$ , $V_{OUT} = 3.3\text{ V}$ , $I_{OUT} = 0.5\text{ A}$ , PWM Mode operation		0.02			% / V

(1) The device is still functional down to Under Voltage Lockout (see parameter  $V_{UVLO}$ ).

(2) Current into  $V_{IN}$  pin.

(3) This is the static current limit. It can be temporarily higher in applications due to internal propagation delay (see [Current Limit and Short Circuit Protection](#)).

(4) For fixed voltage versions, the (internal) resistive feedback divider is included.

(5) The output voltage accuracy in Power Save Mode can be improved by increasing the  $C_{OUT}$  value, reducing the output voltage ripple.

(6) Line and load regulation are depending on external component selection and layout (see [Figure 16](#) and [Figure 17](#)).

### 7.6 Typical Characteristics

At  $V_{IN} = 12\text{ V}$ ,  $V_{OUT} = 3.3\text{ V}$  and  $T_J = 25^\circ\text{C}$  (unless otherwise noted)

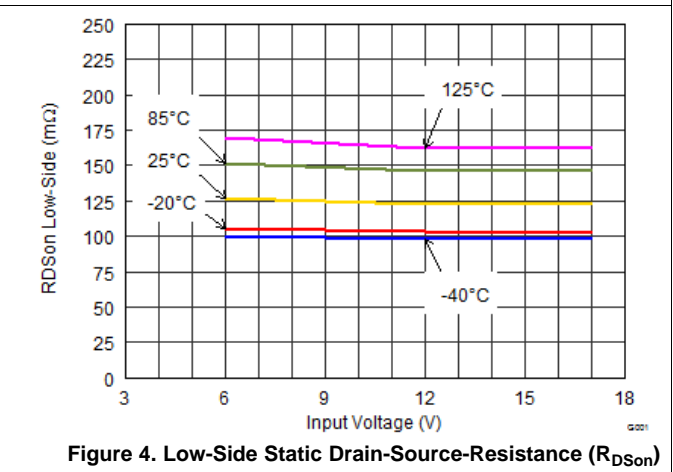
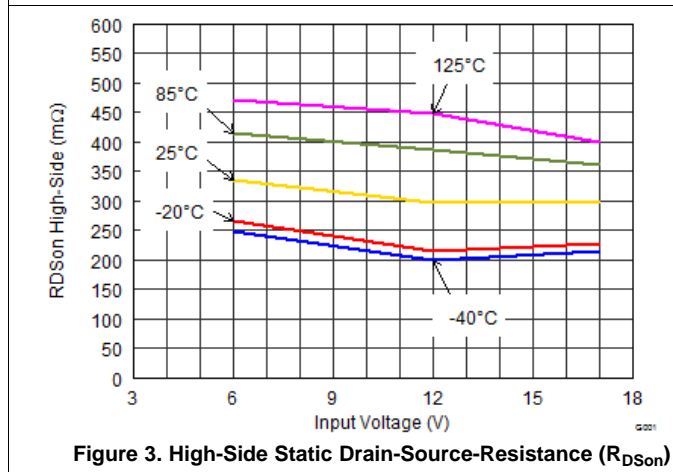
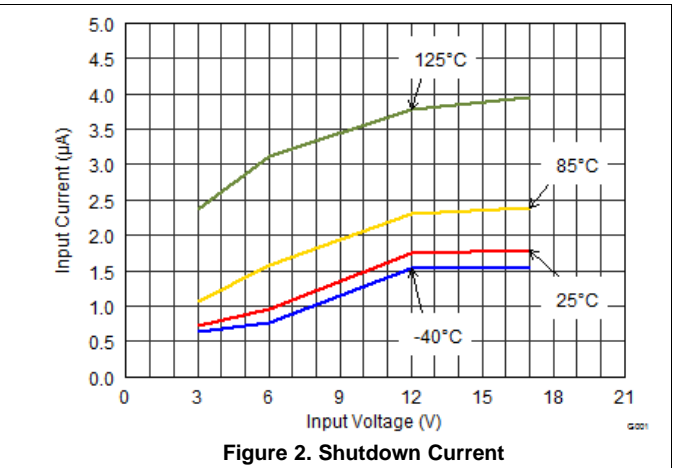
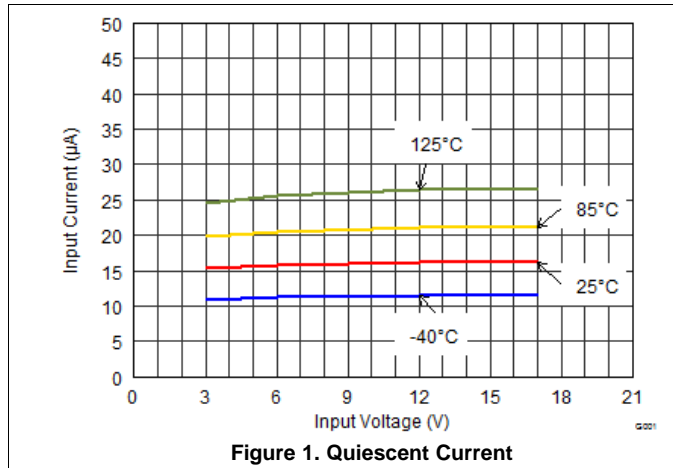



Functional Block Diagram (continued)

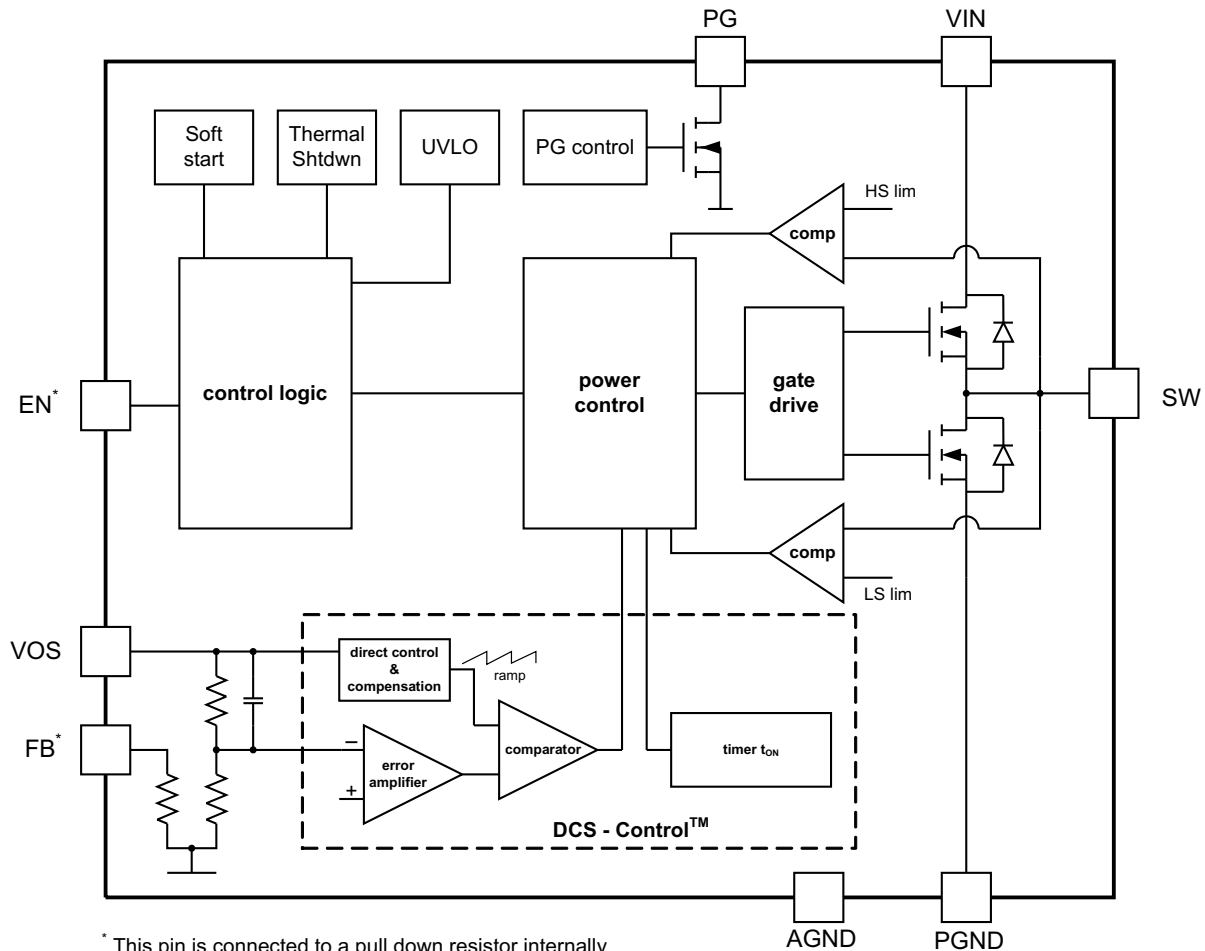

\* This pin is connected to a pull down resistor internally (see Detailed Description section).

Copyright © 2016, Texas Instruments Incorporated

Figure 6. TPS62162-Q1 (Fixed Output Voltage)

8.3 Feature Description

8.3.1 Enable / Shutdown (EN)

When Enable (EN) is set High, the device starts operation.

Shutdown is forced if EN is pulled Low with a shutdown current of typically 1.8  $\mu\text{A}$ . During shutdown, the internal power MOSFETs as well as the entire control circuitry are turned off. The internal resistive divider pulls down the output voltage smoothly. If the EN pin is Low, an internal pulldown resistor of about 400  $\text{k}\Omega$  is connected and keeps it Low in case of a floating pin.

Connecting the EN pin to an appropriate output signal of another power rail provides sequencing of multiple power rails.

8.3.2 Soft Start

The internal soft-start circuitry controls the output voltage slope during start-up. This avoids excessive inrush current and ensures a controlled output voltage rise time. It also prevents unwanted voltage drops from high-impedance power sources or batteries. When EN is set to start device operation, the device starts switching after a delay of about 50  $\mu\text{s}$  and  $V_{\text{OUT}}$  rises with a slope of about 25  $\text{mV}/\mu\text{s}$ . See Figure 28 and Figure 29 for typical start-up operation.



## Feature Description (continued)

The TPS6216x-Q1 can start into a pre-biased output. During monotonic pre-biased start-up, the low-side MOSFET is not allowed to turn on until the internal ramp of the device sets an output voltage above the pre-bias voltage.

### 8.3.3 Power Good (PG)

The TPS6216x-Q1 has a built-in power good (PG) function to indicate whether the output voltage has reached its appropriate level or not. The PG signal can be used for start-up sequencing of multiple rails. The PG pin is an open-drain output that requires a pullup resistor (to any voltage below 7 V). It can sink 2 mA of current and maintain its specified logic low level. It is high impedance when the device is turned off due to EN, UVLO, or thermal shutdown.

### 8.3.4 Undervoltage Lockout (UVLO)

If the input voltage drops, the undervoltage lockout prevents misoperation of the device by switching off both the power FETs. The undervoltage lockout threshold is set typically to 2.7 V. The device is fully operational for voltages above the UVLO threshold and turns off if the input voltage trips the threshold. The converter starts operation again once the input voltage exceeds the threshold by a hysteresis of typically 180 mV.

### 8.3.5 Thermal Shutdown

The junction temperature ( $T_J$ ) of the device is monitored by an internal temperature sensor. If  $T_J$  exceeds 160°C (typ), the device goes into thermal shut down. Both the high-side and low-side power FETs are turned off and PG goes high impedance. When  $T_J$  decreases below the hysteresis amount, the converter resumes normal operation, beginning with soft start. To avoid unstable conditions, a hysteresis of typically 20°C is implemented on the thermal shut down temperature.

## 8.4 Device Functional Modes

### 8.4.1 Pulse Width Modulation (PWM) Operation

The TPS6216x-Q1 operates with pulse width modulation in continuous conduction mode (CCM) with a nominal switching frequency of about 2.25 MHz. The frequency variation in PWM is controlled and depends on  $V_{IN}$ ,  $V_{OUT}$ , and the inductance. The device operates in PWM mode as long the output current is higher than half the ripple current of the inductor. To maintain high efficiency at light loads, the device enters Power Save Mode at the boundary to discontinuous conduction mode (DCM). This happens if the output current becomes smaller than half of the ripple current of the inductor.

### 8.4.2 Power Save Operation

The built-in Power Save Mode of the TPS6216x-Q1 is entered seamlessly, if the load current decreases. This secures a high efficiency in light load operation. The device remains in Power Save Mode as long as the inductor current is discontinuous.

In Power Save Mode, the switching frequency decreases linearly with the load current maintaining high efficiency. The transition in and out of Power Save Mode happens within the entire regulation scheme and is seamless in both directions.

The TPS6216x-Q1 includes a fixed on-time circuitry. This on-time, in steady-state operation, can be estimated as:

$$t_{ON} = \frac{V_{OUT}}{V_{IN}} \times 420\text{ns} \quad (1)$$

For very small output voltages, the on-time increases beyond the result of [Equation 1](#) to stay above an absolute minimum on-time,  $t_{ON(\text{min})}$ , which is around 80 ns to limit switching losses.

The peak inductor current in PSM can be approximated by:

$$I_{LPSM(\text{peak})} = \frac{(V_{IN} - V_{OUT})}{L} \times t_{ON} \quad (2)$$

## Device Functional Modes (continued)

When  $V_{IN}$  decreases to typically 15% above  $V_{OUT}$ , the TPS6216x-Q1 does not enter Power Save Mode, regardless of the load current. The device maintains output regulation in PWM mode.

### 8.4.3 100% Duty-Cycle Operation

The duty cycle of the buck converter is given by  $D = V_{out} / V_{in}$  and increases as the input voltage comes close to the output voltage. In this case, the device starts 100% duty cycle operation turning on the high-side switch 100% of the time. The high-side switch stays turned on as long as the output voltage is below the internal set point. This allows the conversion of small input to output voltage differences (for example, for longest operation time of battery-powered applications). In 100% duty cycle mode, the low-side FET is switched off.

The minimum input voltage to maintain output voltage regulation, depending on the load current and the output voltage level, can be calculated as:

$$V_{IN(min)} = V_{OUT(min)} + I_{OUT} (R_{DS(on)} + R_L)$$

where

- $I_{OUT}$  is the output current
  - $R_{DS(on)}$  is the  $R_{DS(on)}$  of the high-side FET
  - $R_L$  is the DC resistance of the inductor used
- (3)

### 8.4.4 Current Limit and Short Circuit Protection

The TPS6216x-Q1 is protected against heavy load and short circuit events. At heavy loads, the current limit determines the maximum output current. If the current limit is reached, the high-side FET is turned off. Avoiding shoot through current, the low-side FET is then switched on to allow the inductor current to decrease. The high-side FET turns on again, only if the current in the low-side FET has decreased below the low side current limit threshold.

The output current of the device is limited by the current limit (see the [Electrical Characteristics](#)). Due to internal propagation delay, the actual current can exceed the static current limit during that time.

The dynamic current limit can be calculated as follows:

$$I_{peak(typ)} = I_{LIMF} + \frac{V_L}{L} \times t_{PD}$$

where

- $I_{LIMF}$  is the static current limit, specified in the electrical characteristic table
  - $L$  is the inductor value
  - $V_L$  is the voltage across the inductor
  - $t_{PD}$  is the internal propagation delay
- (4)

The dynamic high-side switch peak current can be calculated as follows:

$$I_{peak(typ)} = I_{LIMF\_HS} + \frac{(V_{IN} - V_{OUT})}{L} \times 30ns$$
(5)

Care on the current limit has to be taken if the input voltage is high and very small inductances are used.

### 8.4.5 Operation Above $T_J = 125^\circ\text{C}$

The operating junction temperature of the device is specified up to  $125^\circ\text{C}$ . In power supply circuits, the self heating effect causes the junction temperature,  $T_J$ , to be even higher than the ambient temperature  $T_A$ . Depending on  $T_A$  and the load current, the maximum operating temperature  $T_J$  can be exceeded. However, the electrical characteristics are specified up to a  $T_J$  of  $125^\circ\text{C}$  only. The device operates as long as thermal shutdown threshold is not triggered.

## 9 Application and Implementation

### NOTE

Information in the following applications sections is not part of the TI component specification, and TI does not warrant its accuracy or completeness. TI's customers are responsible for determining suitability of components for their purposes. Customers should validate and test their design implementation to confirm system functionality.

### 9.1 Application Information

The TPS6216x-Q1 is a synchronous switched mode step-down converter, able to convert a 3 V to 17 V input voltage into a lower, 0.9 V to 6 V, output voltage, providing up to 1-A load current. The following section gives guidance on the external component selection to operate the device within the recommended operating conditions.

### 9.2 Typical TPS62160-Q1 Application

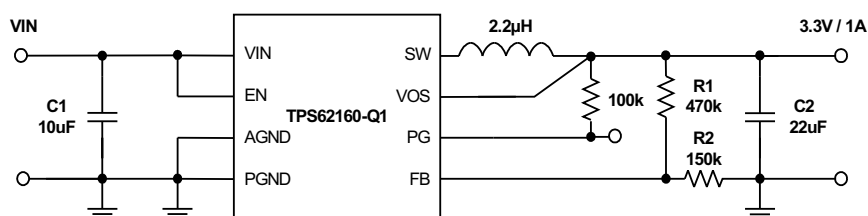

Figure 7. 3.3-V / 1-A Power Supply

#### 9.2.1 Design Requirements

The step-down converter design can be adapted to different output voltage and load current needs by choosing external components appropriate. The following design procedure is adequate for whole VIN, VOUT, and load current range of the TPS6216x-Q1. Using [Table 2](#), the design procedure needs minimum effort.

Table 1. Components Used for Application Characteristics

REFERENCE	DESCRIPTION	MANUFACTURER <sup>(1)</sup>
IC	17-V, 1-A step-down converter, WSON	TPS62160QDSG, Texas Instruments
L1	2.2-µH, 1.4-A, 3 x 2.8 x 1.2 mm	VLF3012ST-2R2M1R4, TDK
C1	10-µF, 25-V, ceramic, 0805	Standard
C2	22-µF, 6.3-V, ceramic, 0805	Standard
R1	Depending on Vout	
R2	Depending on Vout	
R3	100-kΩ, chip, 0603, 1/16-W, 1%	Standard

(1) See [Third-Party Products Disclaimer](#).

#### 9.2.2 Detailed Design Procedure

##### 9.2.2.1 Programming the Output Voltage

While the output voltage of the TPS62160-Q1 is adjustable, the TPS62162-Q1 is programmed to a fixed output voltage of 3.3 V. For the fixed output voltage version, the FB pin is pulled down internally and can be left floating. It is recommended to connect it to AGND to improve thermal resistance. The adjustable version can be programmed for output voltages from 0.9 V to 6 V by using a resistive divider from VOUT to AGND. The voltage at the FB pin is regulated to 800 mV. The value of the output voltage is set by the selection of the resistive divider from [Equation 6](#). It is recommended to choose resistor values which allow a current of at least 2 µA, meaning the value of R2 must not exceed 400 kΩ. Lower resistor values are recommended for highest accuracy and most robust design. For applications requiring lowest current consumption, the use of fixed output voltage versions is recommended.

$$R_1 = R_2 \left( \frac{V_{OUT}}{V_{REF}} - 1 \right)$$

In case the FB pin gets opened, the device clamps the output voltage at the VOS pin to about 7.4 V.

### 9.2.2.2 External Component Selection

The external components have to fulfill the needs of the application, but also the stability criteria of the devices control loop. The TPS6216x-Q1 is optimized to work within a range of external components. The LC output filters inductance and capacitance have to be considered together, creating a double pole, responsible for the corner frequency of the converter (see [Output Filter And Loop Stability](#) section). [Table 2](#) can be used to simplify the output filter component selection.

**Table 2. Recommended LC Output Filter Combinations<sup>(1)</sup>**

	4.7 μF	10 μF	22 μF	47 μF	100 μF	200 μF	400 μF
1 μH							
2.2 μH		√	√ <sup>(2)</sup>	√	√	√	
3.3 μH		√	√	√	√		
4.7 μH							

(1) The values in the table are nominal values. Variations of typically ±20% due to tolerance, saturation, and DC bias are assumed.

(2) This LC combination is the standard value and recommended for most applications.

More detailed information on further LC combinations can be found in the [Optimizing the TPS62130/40/50/60 Output Filter Application Report](#).

#### 9.2.2.2.1 Inductor Selection

The inductor selection is affected by several effects like inductor ripple current, output ripple voltage, PWM-to-PSM transition point, and efficiency. In addition, the inductor selected has to be rated for appropriate saturation current and DC resistance (DCR). [Equation 7](#) and [Equation 8](#) calculate the maximum inductor current under static load conditions.

$$I_{L(max)} = I_{OUT(max)} + \frac{\Delta I_{L(max)}}{2} \tag{7}$$

$$\Delta I_{L(max)} = V_{OUT} \times \left( \frac{1 - \frac{V_{OUT}}{V_{IN(max)}}}{L(min) \times f_{SW}} \right)$$

where

- $I_{L(max)}$  is the maximum inductor current
  - $\Delta I_L$  is the peak-to-peak inductor ripple current
  - $L(min)$  is the minimum effective inductor value
  - $f_{SW}$  is the actual PWM switching frequency
- (8)

Calculating the maximum inductor current using the actual operating conditions gives the minimum saturation current of the inductor needed. A margin of about 20% is recommended to add. A larger inductor value is also useful to get lower ripple current, but increases the transient response time and size as well. The following inductors have been used with the TPS6216x-Q1 and are recommended for use:

**Table 3. List of Inductors**

TYPE	INDUCTANCE [μH]	CURRENT [A] <sup>(1)</sup>	DIMENSIONS [L x B x H] mm	MANUFACTURER <sup>(2)</sup>
VLF3012ST-2R2M1R4	2.2 μH, ±20%	1.9 A	3.0 x 2.8 x 1.2	TDK
VLF302512MT-2R2M	2.2 μH, ±20%	1.9 A	3.0 x 2.5 x 1.2	TDK
VLS252012T-2R2M1R3	2.2 μH, ±20%	1.3 A	2.5 x 2.0 x 1.2	TDK

(1)  $I_{RMS}$  at 40°C rise or  $I_{SAT}$  at 30% drop.

(2) See [Third-Party Products Disclaimer](#).

**Table 3. List of Inductors (continued)**

TYPE	INDUCTANCE [ $\mu$ H]	CURRENT [A] <sup>(1)</sup>	DIMENSIONS [L x B x H] mm	MANUFACTURER <sup>(2)</sup>
XFL3012-222MEC	2.2 $\mu$ H, $\pm$ 20%	1.9 A	3.0 x 3.0 x 1.2	Coilcraft
XFL3012-332MEC	3.3 $\mu$ H, $\pm$ 20%	1.6 A	3.0 x 3.0 x 1.2	Coilcraft
LPS3015-332ML_	3.3 $\mu$ H, $\pm$ 20%	1.4 A	3.0 x 3.0 x 1.4	Coilcraft
NR3015T-2R2M	2.2 $\mu$ H, $\pm$ 20%	1.5 A	3.0 x 3.0 x 1.5	Taiyo Yuden
744025003	3.3 $\mu$ H, $\pm$ 20%	1.5 A	2.8 x 2.8 x 2.8	Wuerth
PSI25201B-2R2MS	2.2 $\mu$ H, $\pm$ 20%	1.3 A	2.0 x 2.5 x 1.2	Cyntec

The TPS6216x-Q1 can be run with an inductor as low as 2.2  $\mu$ H. However, for applications with low input voltages, 3.3  $\mu$ H is recommended to allow the full output current. The inductor value also determines the load current at which Power Save Mode is entered:

$$I_{\text{load(PSM)}} = \frac{1}{2} \Delta I_L \quad (9)$$

Using [Equation 8](#), this current level can be adjusted by changing the inductor value.

### 9.2.2.2.2 Capacitor Selection

#### 9.2.2.2.2.1 Output Capacitor

The recommended value for the output capacitor is 22  $\mu$ F. The architecture of the TPS6216x-Q1 allows the use of tiny ceramic output capacitors with low equivalent series resistance (ESR). These capacitors provide low output voltage ripple and are recommended. To keep its low resistance up to high frequencies and to get narrow capacitance variation with temperature, it is recommended to use X7R or X5R dielectric. Using a higher value can have some advantages like smaller voltage ripple and a tighter DC output accuracy in Power Save Mode (see the [Optimizing the TPS62130/40/50/60 Output Filter Application Report](#)).

#### NOTE

In power save mode, the output voltage ripple depends on the output capacitance, its ESR, and the peak inductor current. Using ceramic capacitors provides small ESR and low ripple.

#### 9.2.2.2.2.2 Input Capacitor

For most applications, 10  $\mu$ F is sufficient and is recommended, though a larger value reduces input current ripple further. The input capacitor buffers the input voltage for transient events and also decouples the converter from the supply. A low ESR multilayer ceramic capacitor is recommended for best filtering and should be placed between VIN and GND as close as possible to those pins.

#### NOTE

**DC Bias effect:** High capacitance ceramic capacitors have a DC Bias effect, which will have a strong influence on the final effective capacitance. Therefore, the right capacitor value has to be chosen carefully. Package size and voltage rating in combination with dielectric material are responsible for differences between the rated capacitor value and the effective capacitance.

### 9.2.2.3 Output Filter And Loop Stability

The TPS6216x-Q1 is internally compensated to be stable with L-C filter combinations corresponding to a corner frequency to be calculated with [Equation 10](#):

$$f_{LC} = \frac{1}{2\pi\sqrt{L \times C}} \quad (10)$$

Proven nominal values for inductance and ceramic capacitance are given in [Table 2](#) and are recommended for use. Different values can work, but care has to be taken on the loop stability which might be affected. More information including a detailed L-C stability matrix can be found in the [Optimizing the TPS62130/40/50/60 Output Filter Application Report](#).

The TPS6216x-Q1 includes an internal 25-pF feedforward capacitor, connected between the VOS and FB pins. This capacitor impacts the frequency behavior and sets a pole and zero in the control loop with the resistors of the feedback divider, per [Equation 11](#) and [Equation 12](#):

$$f_{\text{zero}} = \frac{1}{2\pi \times R_1 \times 25 \text{ pF}} \quad (11)$$

$$f_{\text{pole}} = \frac{1}{2\pi \times 25 \text{ pF}} \times \left( \frac{1}{R_1} + \frac{1}{R_2} \right) \quad (12)$$

Though the TPS6216x-Q1 is stable without the pole and zero being in a particular location, adjusting their location to the specific needs of the application can provide better performance in Power Save mode and improved transient response. An external feedforward capacitor can also be added. A more detailed discussion on the optimization for stability vs transient response can be found in the [Optimizing Transient Response of Internally Compensated DC-DC Converters](#) and [Feedforward Capacitor to Improve Stability and Bandwidth of TPS621/821-Family](#) application reports.

If using ceramic capacitors, the DC bias effect has to be considered. The DC bias effect results in a drop in effective capacitance as the voltage across the capacitor increases (see the note in the [DC Bias effect](#) section).

### 9.2.3 Application Curves

At  $V_{IN} = 12\text{ V}$ ,  $V_{OUT} = 3.3\text{ V}$ , and  $T_J = 25^\circ\text{C}$  (unless otherwise noted)

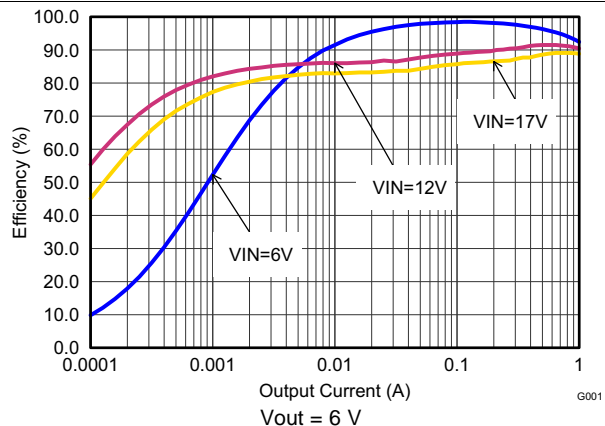

Figure 8. Efficiency versus Output Current

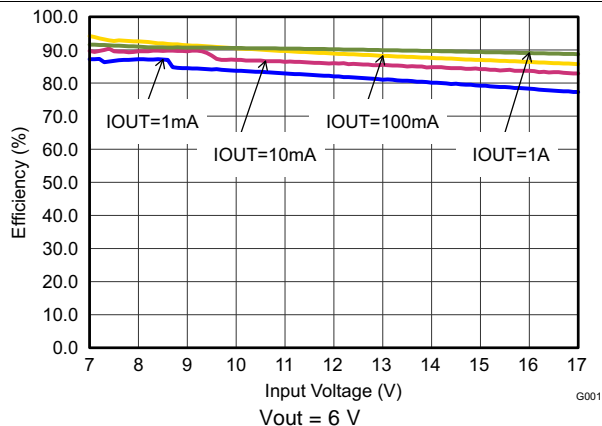

Figure 9. Efficiency versus Input Voltage

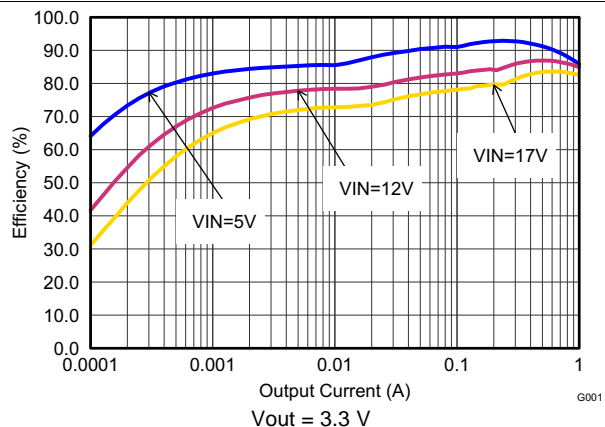

Figure 10. Efficiency versus Output Current

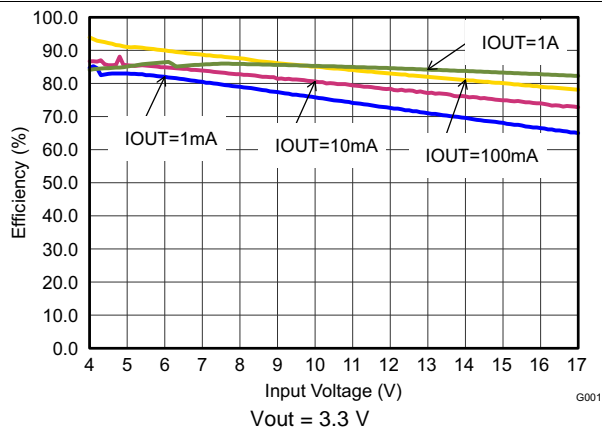

Figure 11. Efficiency versus Input Voltage

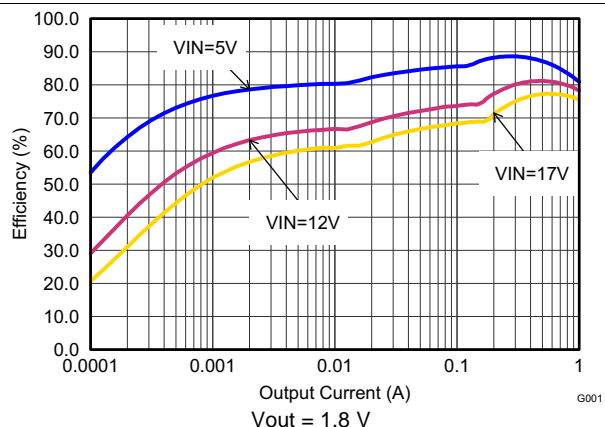

Figure 12. Efficiency versus Output Current

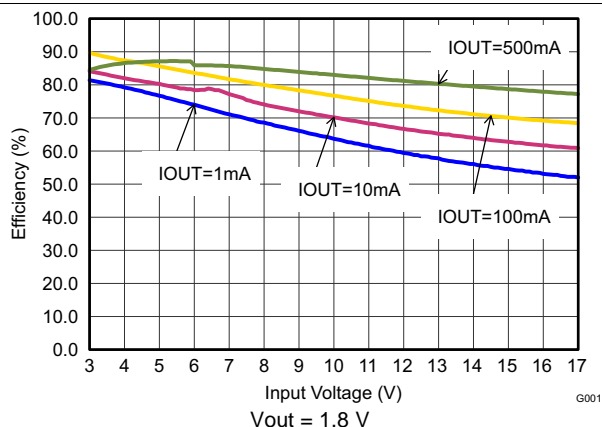

Figure 13. Efficiency versus Input Voltage

At  $V_{IN} = 12\text{ V}$ ,  $V_{OUT} = 3.3\text{ V}$ , and  $T_J = 25^\circ\text{C}$  (unless otherwise noted)

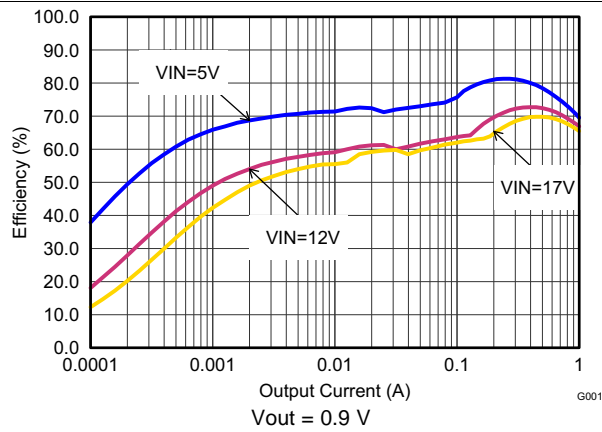

Figure 14. Efficiency versus Output Current

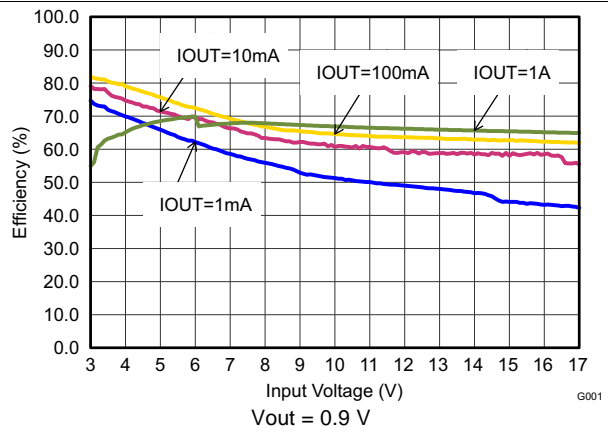

Figure 15. Efficiency versus Input Voltage

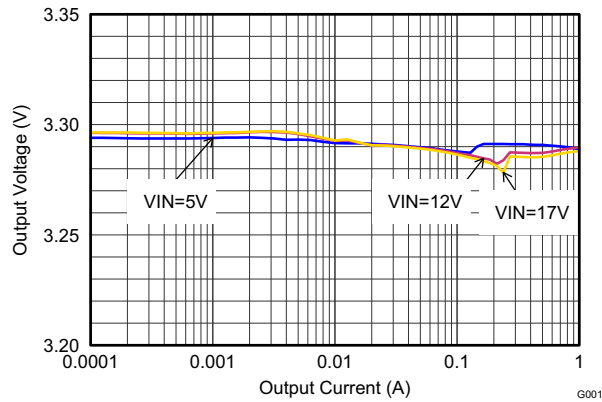

Figure 16. Output Voltage Accuracy (Load Regulation)

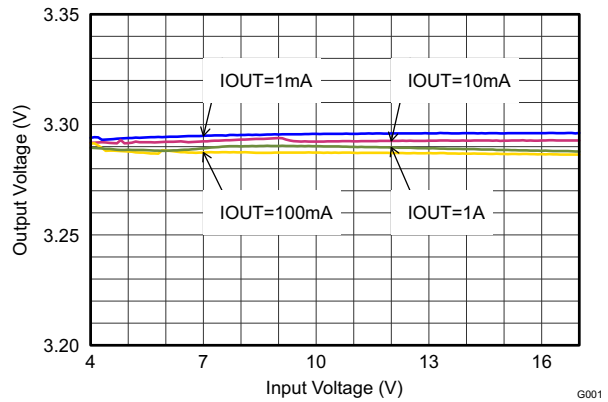

Figure 17. Output Voltage Accuracy (Line Regulation)

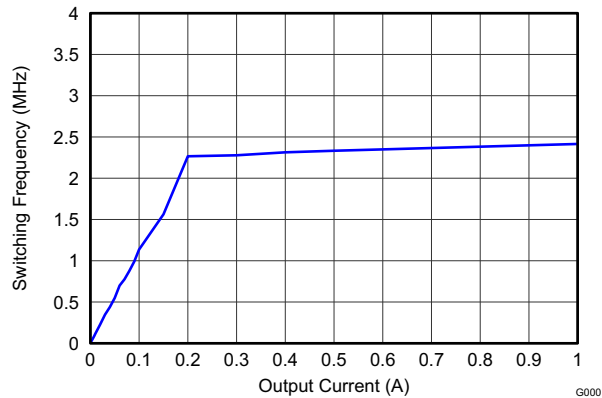

Figure 18. Switching Frequency versus Output Current

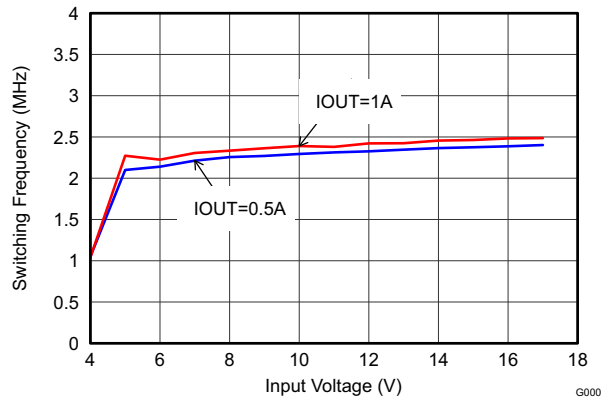

Figure 19. Switching Frequency versus Input Voltage



At  $V_{IN} = 12\text{ V}$ ,  $V_{OUT} = 3.3\text{ V}$ , and  $T_J = 25^\circ\text{C}$  (unless otherwise noted)

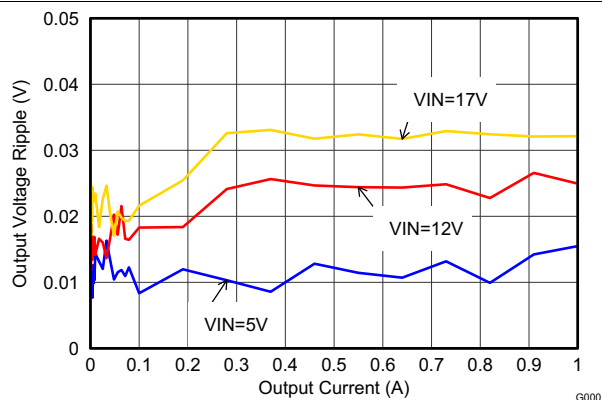

Figure 20. Output Voltage Ripple

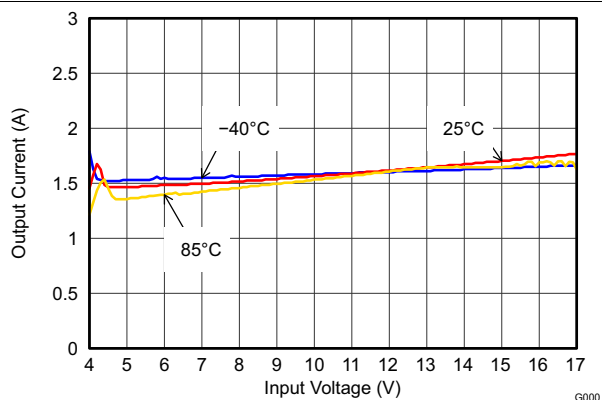

Figure 21. Maximum Output Current

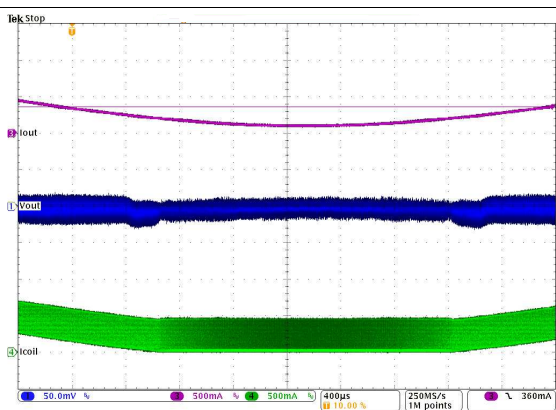

Figure 22. PWM / PSM Mode Transitions

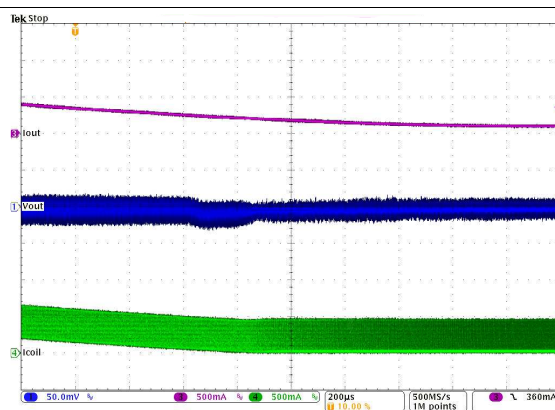
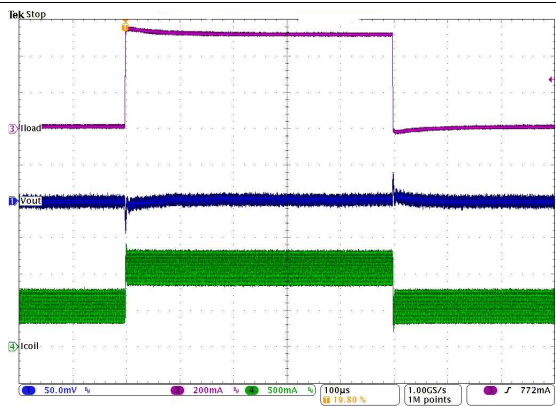
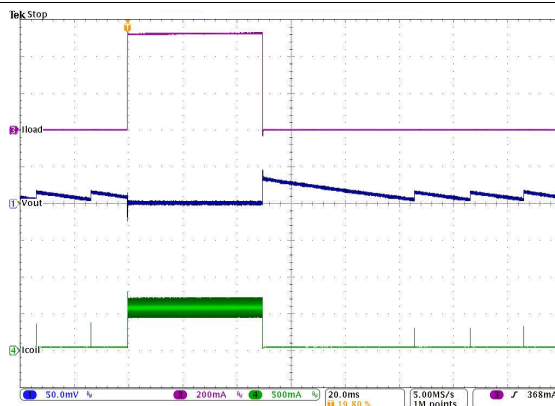

Figure 23. PWM to PSM Mode Transition



500 mA to 1 A

Figure 24. Load Transient Response in PWM Mode



100 mA to 500 mA

Figure 25. Load Transient Response from Power Save Mode

At  $V_{IN} = 12\text{ V}$ ,  $V_{OUT} = 3.3\text{ V}$ , and  $T_J = 25^\circ\text{C}$  (unless otherwise noted)

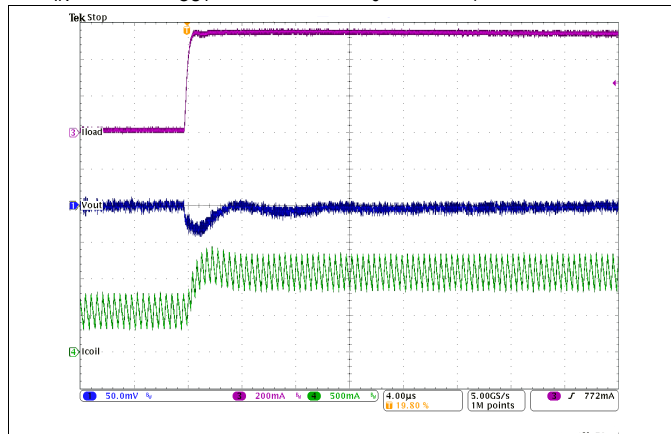

500 mA to 1 A, Rising edge

Figure 26. Load Transient Response in PWM Mode

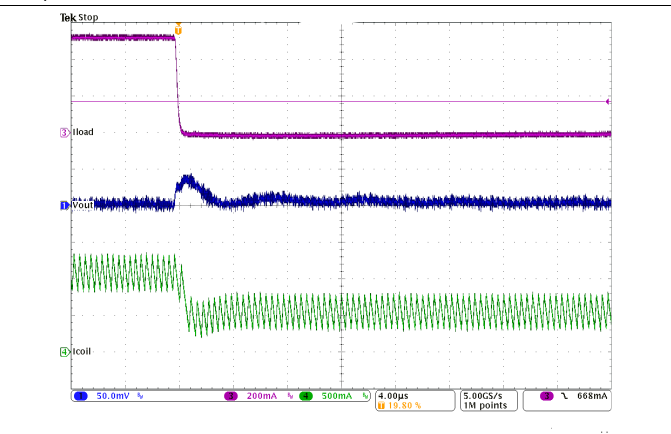

500 mA to 1 A, Falling edge

Figure 27. Load Transient Response in PWM Mode

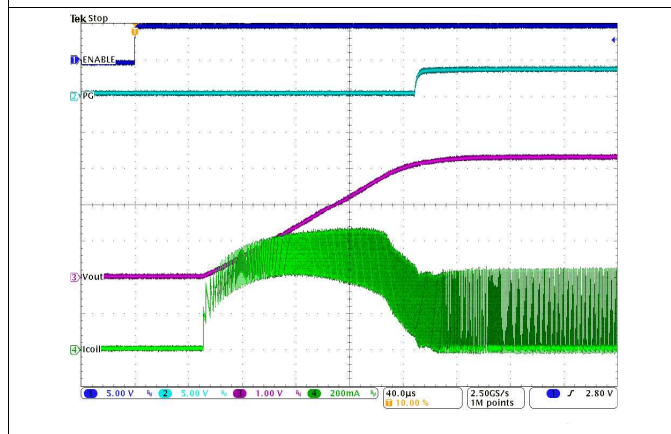

$I_{out} = 100\text{ mA}$

Figure 28. Start-up

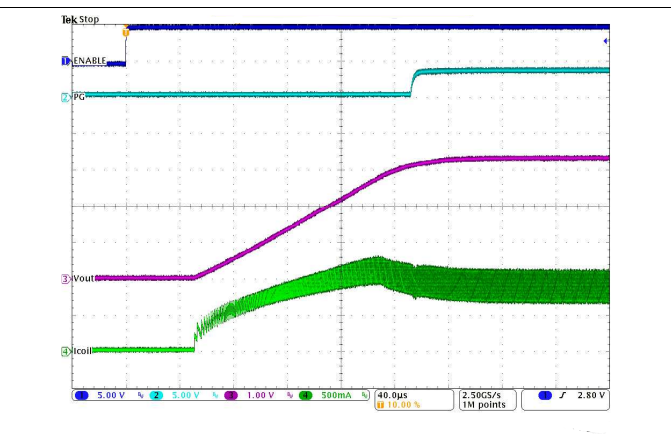

$I_{out} = 1\text{ A}$

Figure 29. Start-up

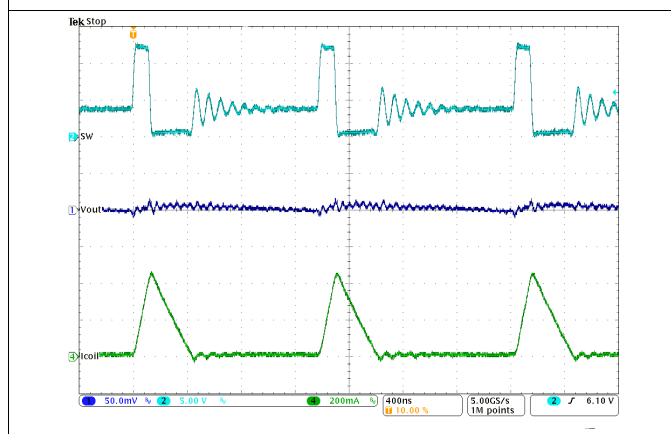

$I_{out} = 66\text{ mA}$

Figure 30. Typical Operation in Power Save Mode

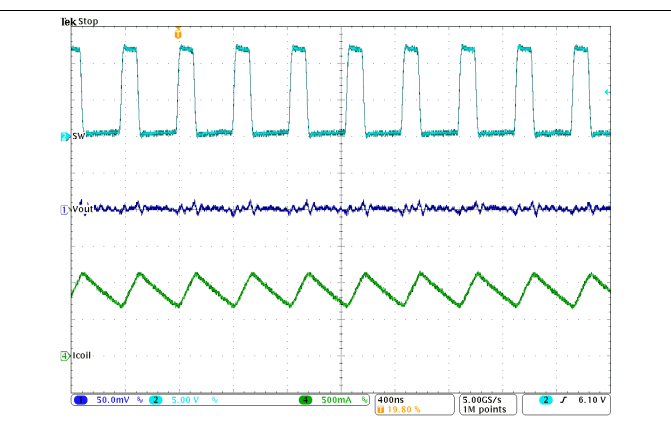

$I_{out} = 1\text{ A}$

Figure 31. Typical Operation in PWM Mode

### 9.3 System Examples

#### 9.3.1 Inverting Power Supply

The TPS6216x-Q1 can be used as inverting power supply by rearranging external circuitry as shown in Figure 32. Since the former GND node now represents a voltage level below system ground, the voltage difference between  $V_{IN}$  and  $V_{OUT}$  has to be limited for operation to the maximum supply voltage of 17 V (see Equation 13).

$$V_{IN} + |V_{OUT}| \leq V_{INmax} \tag{13}$$

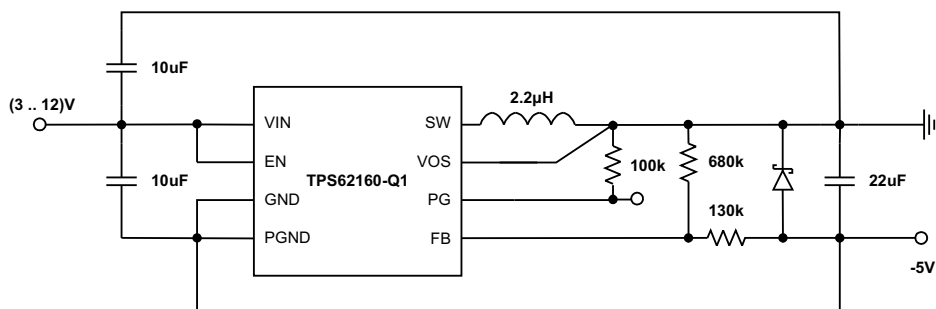

Figure 32. -5-V Inverting Power Supply

The transfer function of the inverting power supply configuration differs from the buck mode transfer function, incorporating a Right Half Plane Zero additionally. The loop stability has to be adapted and an output capacitance of at least 22  $\mu$ F is recommended. A detailed design example is given in the [Using the TPS6215x in an Inverting Buck-Boost Topology Application Report](#).

#### 9.3.2 Various Output Voltages

The TPS62160-Q1 can be set for different output voltages between 0.9 V and 6 V. Some examples are shown below.

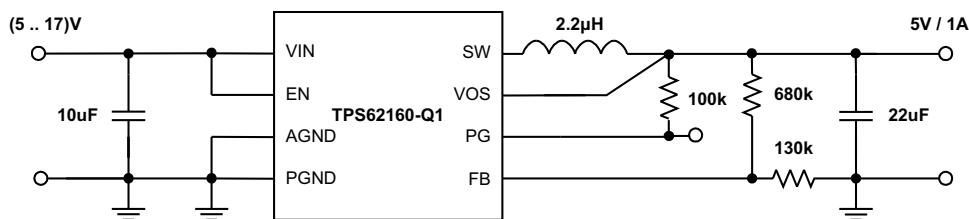

Figure 33. 5-V/1-A Power Supply

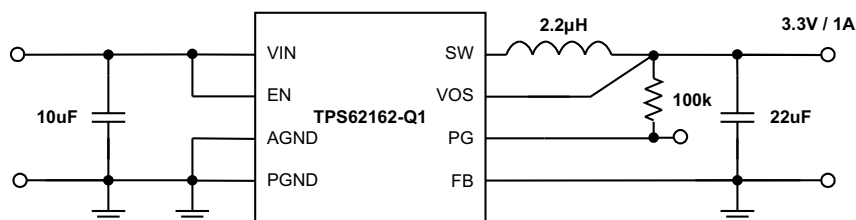

Figure 34. 3.3-V/1-A Power Supply

System Examples (continued)

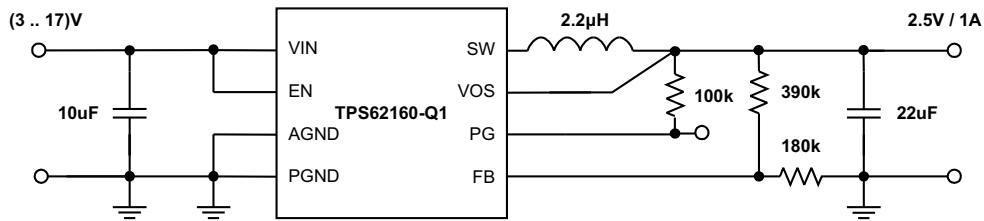

Figure 35. 2.5-V/1-A Power Supply

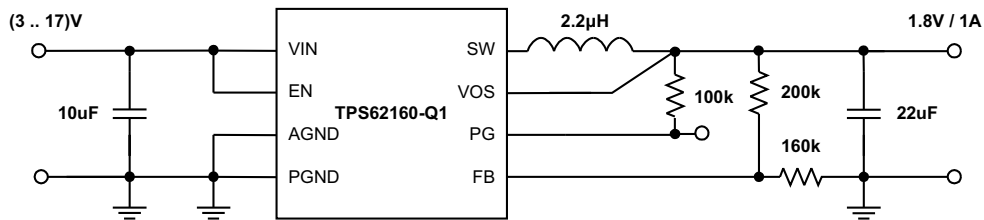

Figure 36. 1.8-V/1-A Power Supply

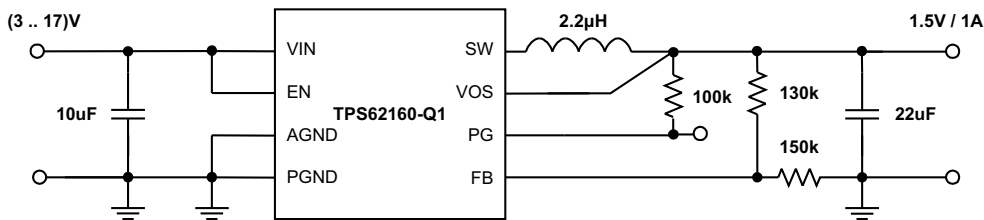

Figure 37. 1.5-V/1-A Power Supply

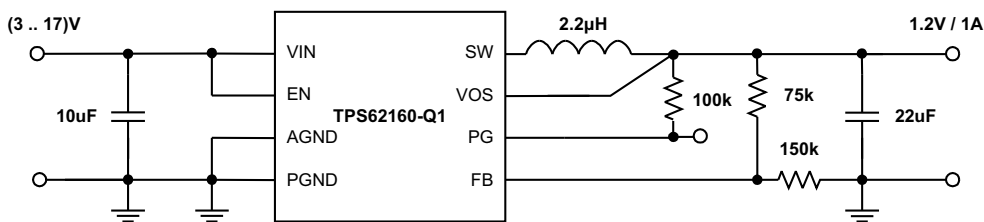

Figure 38. 1.2-V/1-A Power Supply

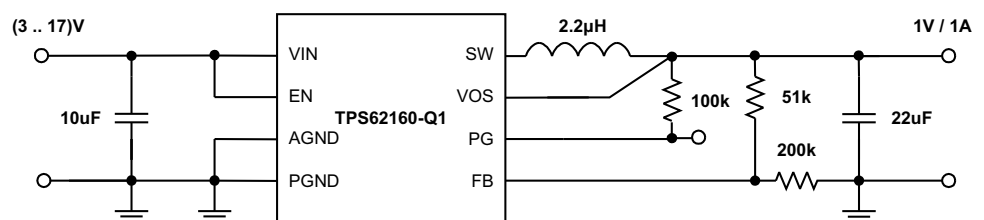

Figure 39. 1-V/1-A Power Supply

## 10 Power Supply Recommendations

The TPS6216x-Q1 are designed to operate from a 3-V to 17-V input voltage supply. The output current of the input power supply needs to be rated according to the output voltage and the output current of the power rail application.

## 11 Layout

### 11.1 Layout Guidelines

A proper layout is critical for the operation of a switched mode power supply, even more at high switching frequencies. Therefore, the PCB layout of the TPS6216x-Q1 demands careful attention to ensure operation and to get the performance specified. A poor layout can lead to issues like poor regulation (both line and load), stability and accuracy weaknesses, increased EMI radiation, and noise sensitivity. Considering the following topics ensures best electrical and optimized thermal performance:

1. The input capacitor must be placed as close as possible to the VIN and PGND pin of the IC. This provides low resistive and inductive path for the high di/dt input current.
2. The VOS pin must be connect in the shortest way to VOUT at the output capacitor - avoiding noise coupling.
3. The feedback resistors, R1 and R2, must be connected close to the FB and AGND pins - avoiding noise coupling.
4. The output capacitor must be placed such that its ground is as close as possible to the PGND pins of the IC - avoiding additional voltage drop in traces.
5. The inductor must be placed close to the SW pin and connect directly to the output capacitor - minimizing the loop area between the SW pin, inductor, output capacitor, and PGND pin.

More detailed information can be found in the [TPS62160EVM-627 and TPS62170EVM-627 Evaluation Modules User's Guide](#).

The Exposed Thermal Pad must be soldered to the circuit board for mechanical reliability and to achieve appropriate power dissipation. Although the Exposed Thermal Pad can be connected to a floating circuit board trace, the device will have better thermal performance if it is connected to a larger ground plane. The Exposed Thermal Pad is electrically connected to AGND.

### 11.2 Layout Example

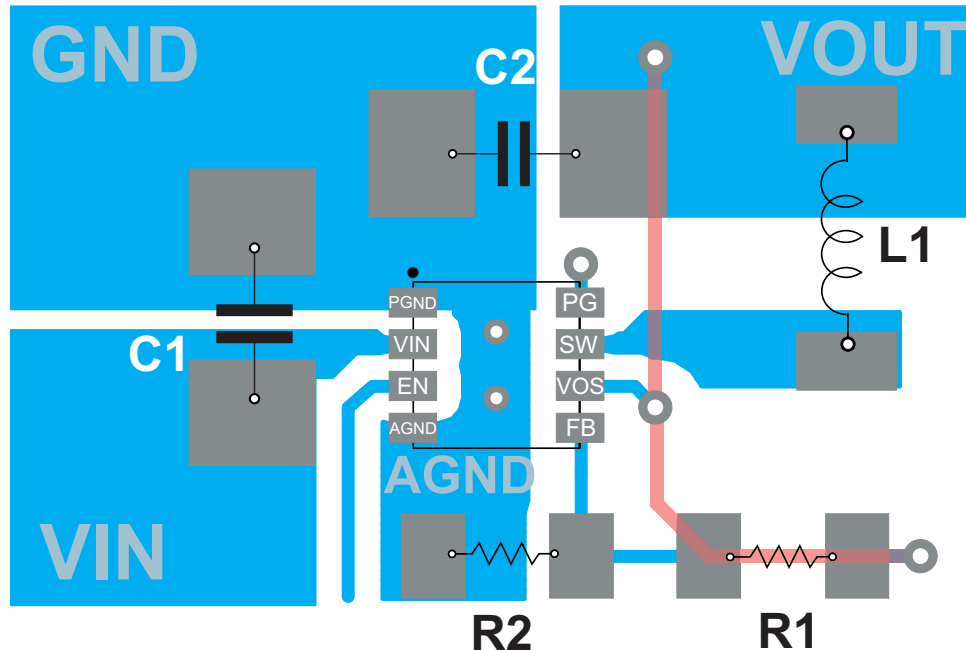

Figure 40. Layout Example

### 11.3 Thermal Considerations

Implementation of integrated circuits in low-profile and fine-pitch surface-mount packages typically requires special attention to power dissipation. Many system-dependent issues such as thermal coupling, airflow, added heat sinks, and convection surfaces, and the presence of other heat-generating components affect the power-dissipation limits of a given component.

The following are three basic approaches for enhancing thermal performance:

- Improving the power dissipation capability of the PCB design
- Improving the thermal coupling of the component to the PCB by soldering the Exposed Thermal Pad
- Introducing airflow in the system

For more details on how to use the thermal parameters, see the [Thermal Characteristics of Linear and Logic Packages Using JEDEC PCB Designs](#) and [Semiconductor and IC Package Thermal Metrics](#) application reports.

The TPS6216x-Q1 are designed for a maximum operating junction temperature ( $T_J$ ) of 125°C. Therefore, the maximum output power is limited by the power losses that can be dissipated over the actual thermal resistance, given by the package and the surrounding PCB structures. Since the thermal resistance of the package is fixed, increasing the size of the surrounding copper area and improving the thermal connection to the IC can reduce the thermal resistance. To get an improved thermal behavior, it is recommended to use top layer metal to connect the device with wide and thick metal lines. Internal ground layers can connect to vias directly under the IC for improved thermal performance.

If short circuit or overload conditions are present, the device is protected by limiting internal power dissipation.

## 12 Device and Documentation Support

### 12.1 Device Support

#### 12.1.1 Third-Party Products Disclaimer

TI'S PUBLICATION OF INFORMATION REGARDING THIRD-PARTY PRODUCTS OR SERVICES DOES NOT CONSTITUTE AN ENDORSEMENT REGARDING THE SUITABILITY OF SUCH PRODUCTS OR SERVICES OR A WARRANTY, REPRESENTATION OR ENDORSEMENT OF SUCH PRODUCTS OR SERVICES, EITHER ALONE OR IN COMBINATION WITH ANY TI PRODUCT OR SERVICE.

### 12.2 Documentation Support

#### 12.2.1 Related Documentation

- [Optimizing the TPS62130/40/50/60/70 Output Filter Application Report](#)
- [Optimizing Transient Response of Internally Compensated dc-dc Converters With Feedforward Capacitor Application Report](#)
- [Using a Feedforward Capacitor to Improve Stability and Bandwidth of TPS62130/40/50/60/70 Application Report](#)
- [TPS62160EVM-627 and TPS62170EVM-627 Evaluation Modules User's Guide](#)
- [Thermal Characteristics of Linear and Logic Packages Using JEDEC PCB Designs Application Report](#)
- [Semiconductor and IC Package Thermal Metrics Application Report](#)

### 12.3 Related Links

The table below lists quick access links. Categories include technical documents, support and community resources, tools and software, and quick access to sample or buy.

Table 4. Related Links

PARTS	PRODUCT FOLDER	SAMPLE & BUY	TECHNICAL DOCUMENTS	TOOLS & SOFTWARE	SUPPORT & COMMUNITY
TPS62160-Q1	<a href="#">Click here</a>	<a href="#">Click here</a>	<a href="#">Click here</a>	<a href="#">Click here</a>	<a href="#">Click here</a>
TPS62162-Q1	<a href="#">Click here</a>	<a href="#">Click here</a>	<a href="#">Click here</a>	<a href="#">Click here</a>	<a href="#">Click here</a>

### 12.4 Receiving Notification of Documentation Updates

To receive notification of documentation updates, navigate to the device product folder on ti.com. In the upper right corner, click on *Alert me* to register and receive a weekly digest of any product information that has changed. For change details, review the revision history included in any revised document.

### 12.5 Support Resources

TI E2E™ support forums are an engineer's go-to source for fast, verified answers and design help — straight from the experts. Search existing answers or ask your own question to get the quick design help you need.

Linked content is provided "AS IS" by the respective contributors. They do not constitute TI specifications and do not necessarily reflect TI's views; see TI's [Terms of Use](#).

### 12.6 Trademarks

DCS-Control, E2E are trademarks of Texas Instruments.  
All other trademarks are the property of their respective owners.

### 12.7 Electrostatic Discharge Caution



These devices have limited built-in ESD protection. The leads should be shorted together or the device placed in conductive foam during storage or handling to prevent electrostatic damage to the MOS gates.



## 12.8 Glossary

[SLYZ022](#) — *TI Glossary*.

This glossary lists and explains terms, acronyms, and definitions.

## 13 Mechanical, Packaging, and Orderable Information

The following pages include mechanical, packaging, and orderable information. This information is the most current data available for the designated devices. This data is subject to change without notice and revision of this document. For browser-based versions of this data sheet, refer to the left-hand navigation.

## PACKAGING INFORMATION

Orderable Device	Status (1)	Package Type	Package Drawing	Pins	Package Qty	Eco Plan (2)	Lead finish/ Ball material (6)	MSL Peak Temp (3)	Op Temp (°C)	Device Marking (4/5)	Samples
TPS62160QDSGRQ1	ACTIVE	WSON	DSG	8	3000	RoHS & Green	NIPDAU	Level-2-260C-1 YEAR	-40 to 125	QTVQ	<a href="#">Samples</a>
TPS62160QDSGTQ1	ACTIVE	WSON	DSG	8	250	RoHS & Green	NIPDAU	Level-2-260C-1 YEAR	-40 to 125	QTVQ	<a href="#">Samples</a>
TPS62162QDSGRQ1	ACTIVE	WSON	DSG	8	3000	RoHS & Green	NIPDAU	Level-2-260C-1 YEAR	-40 to 125	QUCQ	<a href="#">Samples</a>
TPS62162QDSGTQ1	ACTIVE	WSON	DSG	8	250	RoHS & Green	NIPDAU	Level-2-260C-1 YEAR	-40 to 125	QUCQ	<a href="#">Samples</a>

(1) The marketing status values are defined as follows:

**ACTIVE:** Product device recommended for new designs.

**LIFEBUY:** TI has announced that the device will be discontinued, and a lifetime-buy period is in effect.

**NRND:** Not recommended for new designs. Device is in production to support existing customers, but TI does not recommend using this part in a new design.

**PREVIEW:** Device has been announced but is not in production. Samples may or may not be available.

**OBSOLETE:** TI has discontinued the production of the device.

(2) **RoHS:** TI defines "RoHS" to mean semiconductor products that are compliant with the current EU RoHS requirements for all 10 RoHS substances, including the requirement that RoHS substance do not exceed 0.1% by weight in homogeneous materials. Where designed to be soldered at high temperatures, "RoHS" products are suitable for use in specified lead-free processes. TI may reference these types of products as "Pb-Free".

**RoHS Exempt:** TI defines "RoHS Exempt" to mean products that contain lead but are compliant with EU RoHS pursuant to a specific EU RoHS exemption.

**Green:** TI defines "Green" to mean the content of Chlorine (Cl) and Bromine (Br) based flame retardants meet JS709B low halogen requirements of <=1000ppm threshold. Antimony trioxide based flame retardants must also meet the <=1000ppm threshold requirement.

(3) MSL, Peak Temp. - The Moisture Sensitivity Level rating according to the JEDEC industry standard classifications, and peak solder temperature.

(4) There may be additional marking, which relates to the logo, the lot trace code information, or the environmental category on the device.

(5) Multiple Device Markings will be inside parentheses. Only one Device Marking contained in parentheses and separated by a "-" will appear on a device. If a line is indented then it is a continuation of the previous line and the two combined represent the entire Device Marking for that device.

(6) Lead finish/Ball material - Orderable Devices may have multiple material finish options. Finish options are separated by a vertical ruled line. Lead finish/Ball material values may wrap to two lines if the finish value exceeds the maximum column width.

**Important Information and Disclaimer:** The information provided on this page represents TI's knowledge and belief as of the date that it is provided. TI bases its knowledge and belief on information provided by third parties, and makes no representation or warranty as to the accuracy of such information. Efforts are underway to better integrate information from third parties. TI has taken and

continues to take reasonable steps to provide representative and accurate information but may not have conducted destructive testing or chemical analysis on incoming materials and chemicals. TI and TI suppliers consider certain information to be proprietary, and thus CAS numbers and other limited information may not be available for release.

In no event shall TI's liability arising out of such information exceed the total purchase price of the TI part(s) at issue in this document sold by TI to Customer on an annual basis.

**OTHER QUALIFIED VERSIONS OF TPS62160-Q1, TPS62162-Q1 :**

- Catalog: [TPS62160](#), [TPS62162](#)

NOTE: Qualified Version Definitions:

- Catalog - TI's standard catalog product

## TAPE AND REEL INFORMATION

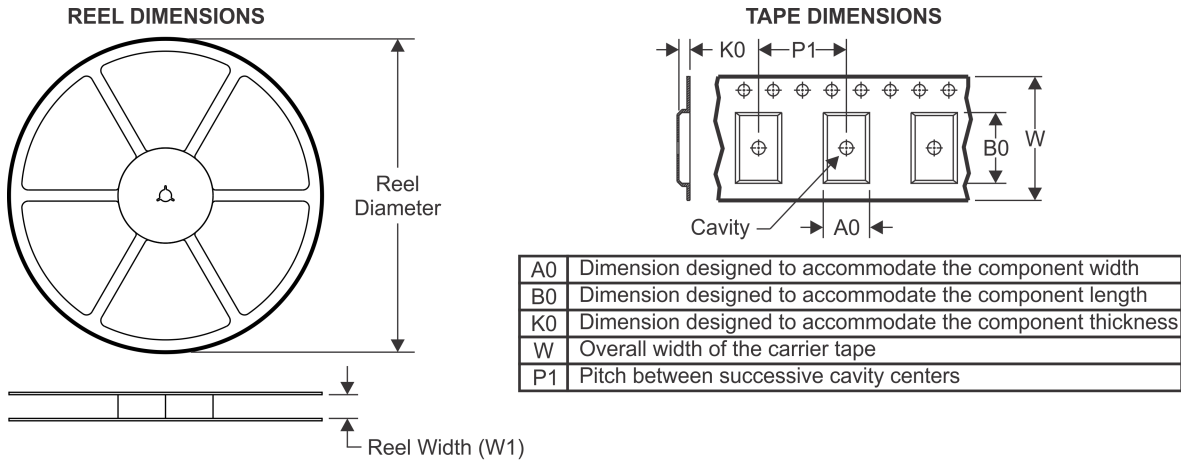

### QUADRANT ASSIGNMENTS FOR PIN 1 ORIENTATION IN TAPE

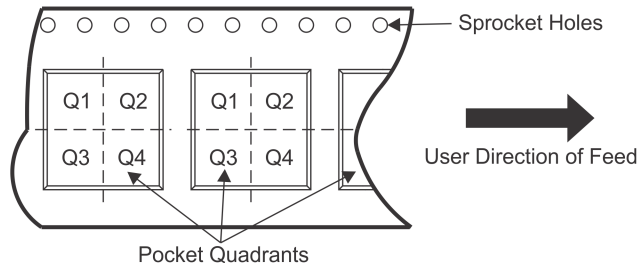

\*All dimensions are nominal

Device	Package Type	Package Drawing	Pins	SPQ	Reel Diameter (mm)	Reel Width W1 (mm)	A0 (mm)	B0 (mm)	K0 (mm)	P1 (mm)	W (mm)	Pin1 Quadrant
TPS62160QDSGRQ1	WSON	DSG	8	3000	180.0	8.4	2.3	2.3	1.15	4.0	8.0	Q2
TPS62160QDSGTQ1	WSON	DSG	8	250	180.0	8.4	2.3	2.3	1.15	4.0	8.0	Q2
TPS62162QDSGRQ1	WSON	DSG	8	3000	180.0	8.4	2.3	2.3	1.15	4.0	8.0	Q2
TPS62162QDSGTQ1	WSON	DSG	8	250	180.0	8.4	2.3	2.3	1.15	4.0	8.0	Q2

## TAPE AND REEL BOX DIMENSIONS

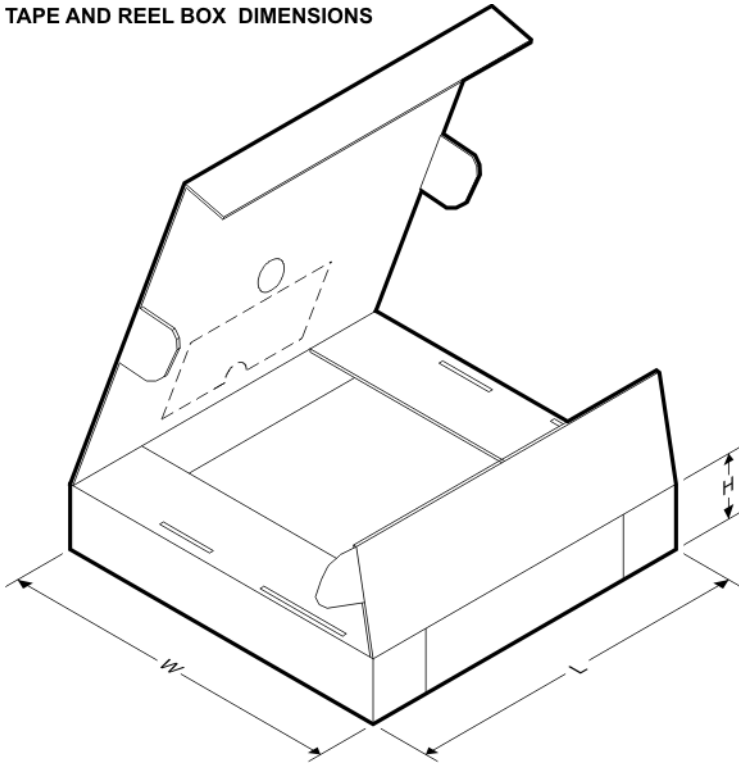

\*All dimensions are nominal

Device	Package Type	Package Drawing	Pins	SPQ	Length (mm)	Width (mm)	Height (mm)
TPS62160QDSGRQ1	WSON	DSG	8	3000	210.0	185.0	35.0
TPS62160QDSGTQ1	WSON	DSG	8	250	210.0	185.0	35.0
TPS62162QDSGRQ1	WSON	DSG	8	3000	210.0	185.0	35.0
TPS62162QDSGTQ1	WSON	DSG	8	250	210.0	185.0	35.0

## GENERIC PACKAGE VIEW

**DSG 8**

**WSON - 0.8 mm max height**

2 x 2, 0.5 mm pitch

PLASTIC SMALL OUTLINE - NO LEAD

This image is a representation of the package family, actual package may vary.  
Refer to the product data sheet for package details.



# DSG0008A

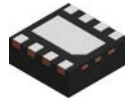

# PACKAGE OUTLINE

## WSON - 0.8 mm max height

PLASTIC SMALL OUTLINE - NO LEAD

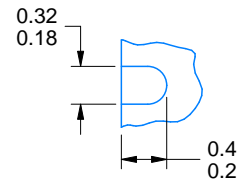

ALTERNATIVE TERMINAL SHAPE TYPICAL

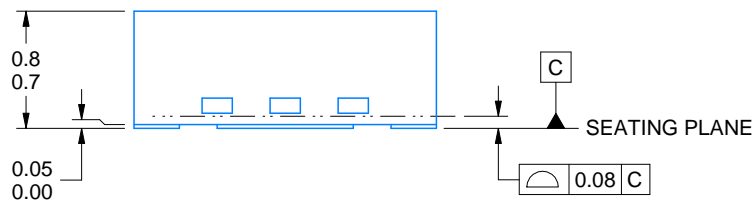

SIDE WALL METAL THICKNESS DIM A	
OPTION 1	OPTION 2
0.1	0.2

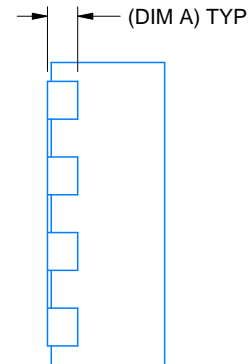
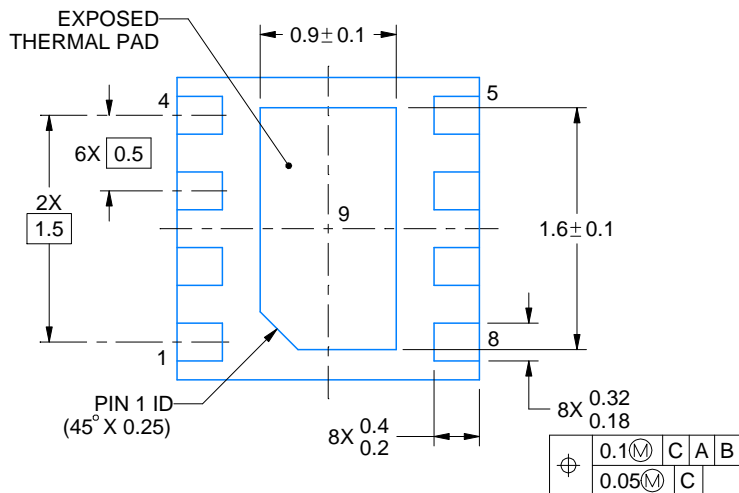

4218900/E 08/2022

### NOTES:

1. All linear dimensions are in millimeters. Any dimensions in parenthesis are for reference only. Dimensioning and tolerancing per ASME Y14.5M.
2. This drawing is subject to change without notice.
3. The package thermal pad must be soldered to the printed circuit board for thermal and mechanical performance.

# EXAMPLE BOARD LAYOUT

DSG0008A

WSON - 0.8 mm max height

PLASTIC SMALL OUTLINE - NO LEAD



LAND PATTERN EXAMPLE  
SCALE:20X



SOLDER MASK DETAILS

4218900/E 08/2022

NOTES: (continued)

4. This package is designed to be soldered to a thermal pad on the board. For more information, see Texas Instruments literature number SLUA271 ([www.ti.com/lit/slua271](http://www.ti.com/lit/slua271)).
5. Vias are optional depending on application, refer to device data sheet. If any vias are implemented, refer to their locations shown on this view. It is recommended that vias under paste be filled, plugged or tented.



# EXAMPLE STENCIL DESIGN

DSG0008A

WSON - 0.8 mm max height

PLASTIC SMALL OUTLINE - NO LEAD

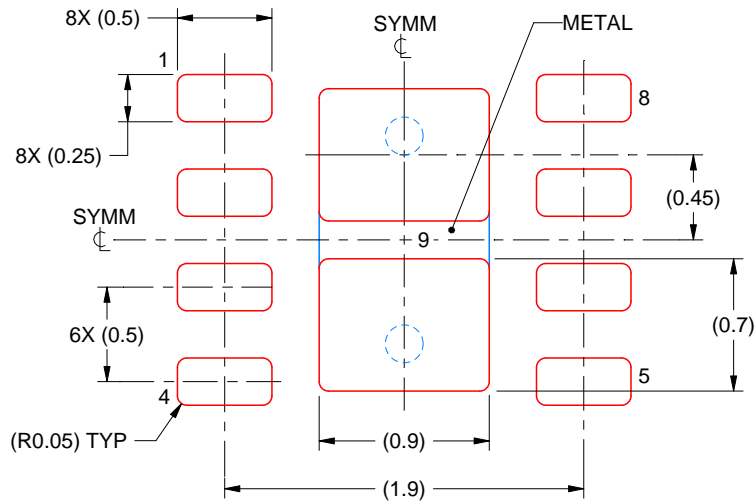

SOLDER PASTE EXAMPLE  
BASED ON 0.125 mm THICK STENCIL

EXPOSED PAD 9:  
87% PRINTED SOLDER COVERAGE BY AREA UNDER PACKAGE  
SCALE:25X

4218900/E 08/2022

NOTES: (continued)

6. Laser cutting apertures with trapezoidal walls and rounded corners may offer better paste release. IPC-7525 may have alternate design recommendations.

## IMPORTANT NOTICE AND DISCLAIMER

TI PROVIDES TECHNICAL AND RELIABILITY DATA (INCLUDING DATA SHEETS), DESIGN RESOURCES (INCLUDING REFERENCE DESIGNS), APPLICATION OR OTHER DESIGN ADVICE, WEB TOOLS, SAFETY INFORMATION, AND OTHER RESOURCES "AS IS" AND WITH ALL FAULTS, AND DISCLAIMS ALL WARRANTIES, EXPRESS AND IMPLIED, INCLUDING WITHOUT LIMITATION ANY IMPLIED WARRANTIES OF MERCHANTABILITY, FITNESS FOR A PARTICULAR PURPOSE OR NON-INFRINGEMENT OF THIRD PARTY INTELLECTUAL PROPERTY RIGHTS.

These resources are intended for skilled developers designing with TI products. You are solely responsible for (1) selecting the appropriate TI products for your application, (2) designing, validating and testing your application, and (3) ensuring your application meets applicable standards, and any other safety, security, regulatory or other requirements.

These resources are subject to change without notice. TI grants you permission to use these resources only for development of an application that uses the TI products described in the resource. Other reproduction and display of these resources is prohibited. No license is granted to any other TI intellectual property right or to any third party intellectual property right. TI disclaims responsibility for, and you will fully indemnify TI and its representatives against, any claims, damages, costs, losses, and liabilities arising out of your use of these resources.

TI's products are provided subject to [TI's Terms of Sale](#) or other applicable terms available either on [ti.com](http://ti.com) or provided in conjunction with such TI products. TI's provision of these resources does not expand or otherwise alter TI's applicable warranties or warranty disclaimers for TI products.

TI objects to and rejects any additional or different terms you may have proposed.

Mailing Address: Texas Instruments, Post Office Box 655303, Dallas, Texas 75265  
Copyright © 2022, Texas Instruments Incorporated