



SGM2068

500mA, Fast Transient Response, Low Voltage, Low Noise and Low Dropout Linear Regulator

GENERAL DESCRIPTION

The SGM2068 is a CMOS, fast transient response, low voltage and low dropout voltage linear regulator. It is capable of supplying 500mA output current with typical dropout voltage of only 70mV. The fixed output voltage range is from 0.55V to 4.2V and adjustable output voltage range is from 0.55V to 5.0V.

Other features include logic-controlled shutdown mode, short-circuit current limit and thermal shutdown protection. The SGM2068 has automatic discharge function to quickly discharge V_{OUT} in the disabled status.

The SGM2068 is available in Green SOT-23-5 and TDFN-2x2-6AL packages. It operates over an operating temperature range of -40°C to $+125^{\circ}\text{C}$.

APPLICATIONS

Portable Equipment

Industrial and Medical Equipment

FEATURES

- Operating Input Voltage Range: 1.5V to 5.5V
- Fixed Output from 0.55V to 4.2V
- Adjustable Output from 0.55V to 5.0V
- 500mA Output Current
- Output Voltage Accuracy: $\pm 1\%$ at $+25^{\circ}\text{C}$
- Quiescent Current: 85 μA (TYP)
- Low Dropout Voltage:
70mV (TYP) at 500mA, $V_{OUT} = 3.3\text{V}$
- Low Noise: 16 μV_{RMS} (TYP)
- Current Limiting and Thermal Protection
- Excellent Load and Line Transient Responses
- With Output Automatic Discharge
- Stable with Small Case Size Ceramic Capacitors
- UVLO with Hysteresis
- -40°C to $+125^{\circ}\text{C}$ Operating Temperature Range
- Available in Green SOT-23-5 and TDFN-2x2-6AL Packages

TYPICAL APPLICATION CIRCUITS

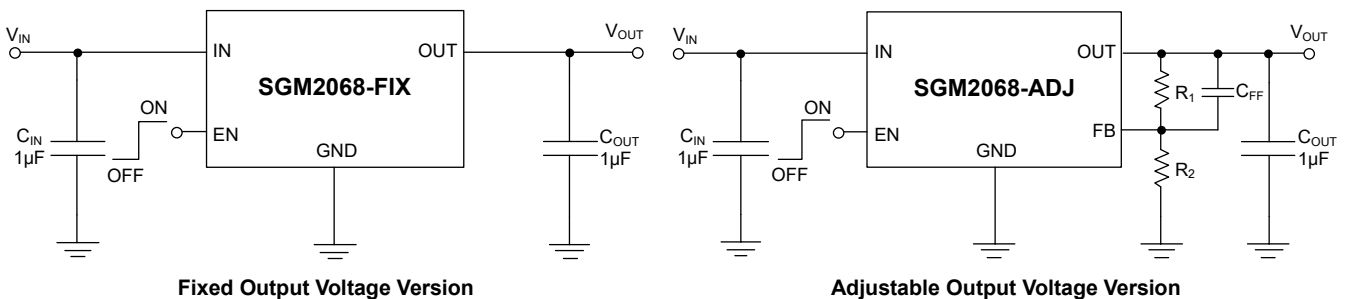

Figure 1. Typical Application Circuits

ABSOLUTE MAXIMUM RATINGS

IN to GND	-0.3V to 6V
OUT, FB to GND.....	-0.3V to (V _{IN} + 0.3V)
EN to GND.....	-0.3V to 6V
Package Thermal Resistance	
SOT-23-5, θ_{JA}	181°C/W
SOT-23-5, θ_{JB}	39°C/W
SOT-23-5, θ_{JC}	74°C/W
TDFN-2x2-6AL, θ_{JA}	70°C/W
TDFN-2x2-6AL, θ_{JB}	34°C/W
TDFN-2x2-6AL, $\theta_{JC(TOP)}$	50°C/W
TDFN-2x2-6AL, $\theta_{JC(BOT)}$	15°C/W
Junction Temperature	+150°C
Storage Temperature Range.....	-65°C to +150°C
Lead Temperature (Soldering, 10s)	+260°C
ESD Susceptibility	
HBM.....	8000V
CDM	1000V

RECOMMENDED OPERATING CONDITIONS

Input Voltage Range	1.5V to 5.5V
Enable Input Voltage Range	0V to 5.5V
Input Effective Capacitance, C _{IN}	0.5 μ F (MIN)
Output Effective Capacitance, C _{OUT}	0.5 μ F to 220 μ F
Operating Junction Temperature Range.....	-40°C to +125°C

OVERSTRESS CAUTION

Stresses beyond those listed in Absolute Maximum Ratings may cause permanent damage to the device. Exposure to absolute maximum rating conditions for extended periods may affect reliability. Functional operation of the device at any conditions beyond those indicated in the Recommended Operating Conditions section is not implied.

ESD SENSITIVITY CAUTION

This integrated circuit can be damaged if ESD protections are not considered carefully. SGMICRO recommends that all integrated circuits be handled with appropriate precautions. Failure to observe proper handling and installation procedures can cause damage. ESD damage can range from subtle performance degradation to complete device failure. Precision integrated circuits may be more susceptible to damage because even small parametric changes could cause the device not to meet the published specifications.

DISCLAIMER

SG Micro Corp reserves the right to make any change in circuit design, or specifications without prior notice.

SGM2068 500mA, Fast Transient Response, Low Voltage, Low Noise and Low Dropout Linear Regulator

PIN CONFIGURATIONS

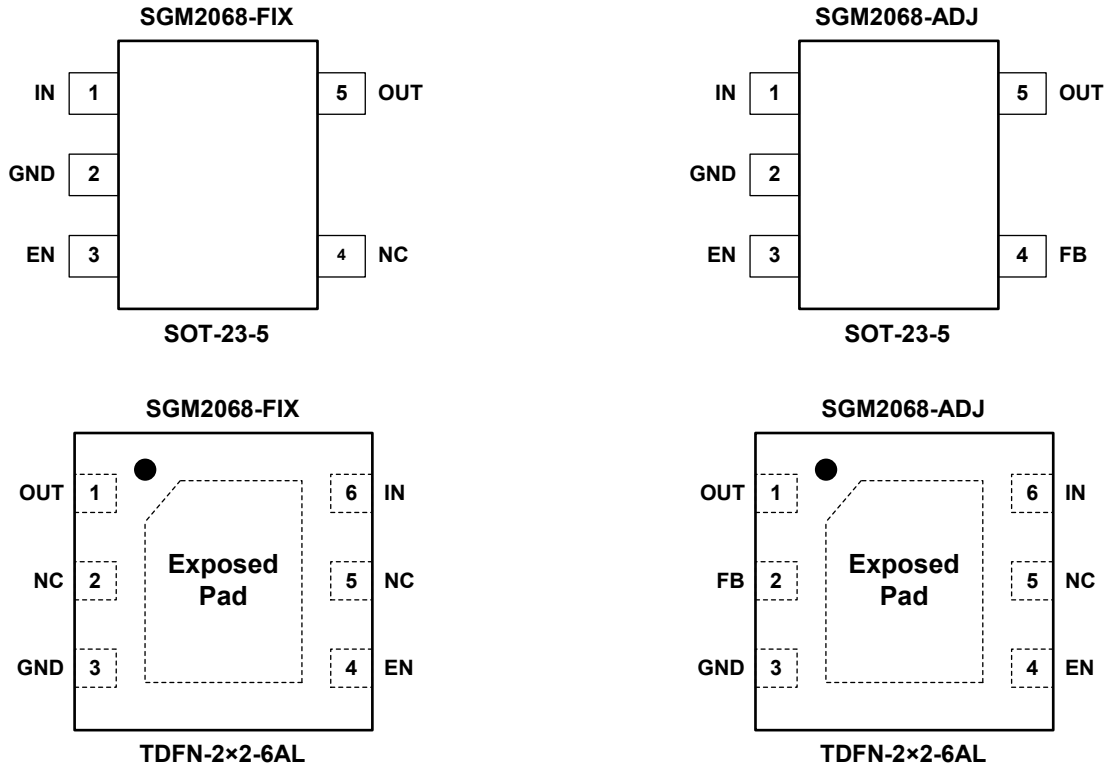

PIN DESCRIPTION

PIN		NAME	FUNCTION
SOT-23-5	TDFN-2x2-6AL		
1	6	IN	Input Supply Voltage Pin. It is recommended to use a 1μF or larger ceramic capacitor from IN pin to ground to get good power supply decoupling. This ceramic capacitor should be placed as close as possible to IN pin.
2	3	GND	Ground.
3	4	EN	Enable Pin. Drive EN high or leave it floating to turn on the regulator. Drive EN low to turn off the regulator.
4	2	NC	No Connection (fixed voltage version only).
		FB	Feedback Pin (adjustable voltage version only). Connect this pin to the midpoint of an external resistor divider to adjust the output voltage. Place the resistors as close as possible to this pin.
5	1	OUT	Regulator Output Pin. It is recommended to use a ceramic capacitor with effective capacitance in the range of 0.5μF to 220μF to ensure stability. This ceramic capacitor should be placed as close as possible to OUT pin.
—	5	NC	No Connection.
—	Exposed Pad	—	Exposed Pad. Connect it to GND internally. Connect it to a large ground plane to maximize thermal performance. This pad is not an electrical connection point.

SGM2068 500mA, Fast Transient Response, Low Voltage, Low Noise and Low Dropout Linear Regulator

FUNCTIONAL BLOCK DIAGRAMS

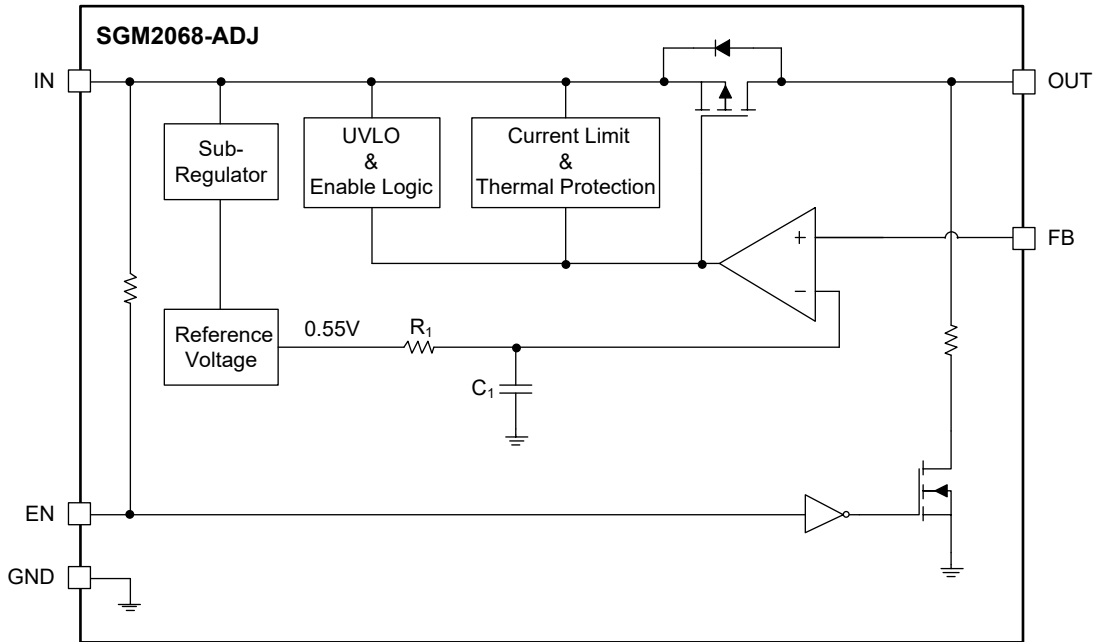

Figure 2. Block Diagram for Adjustable Output Version

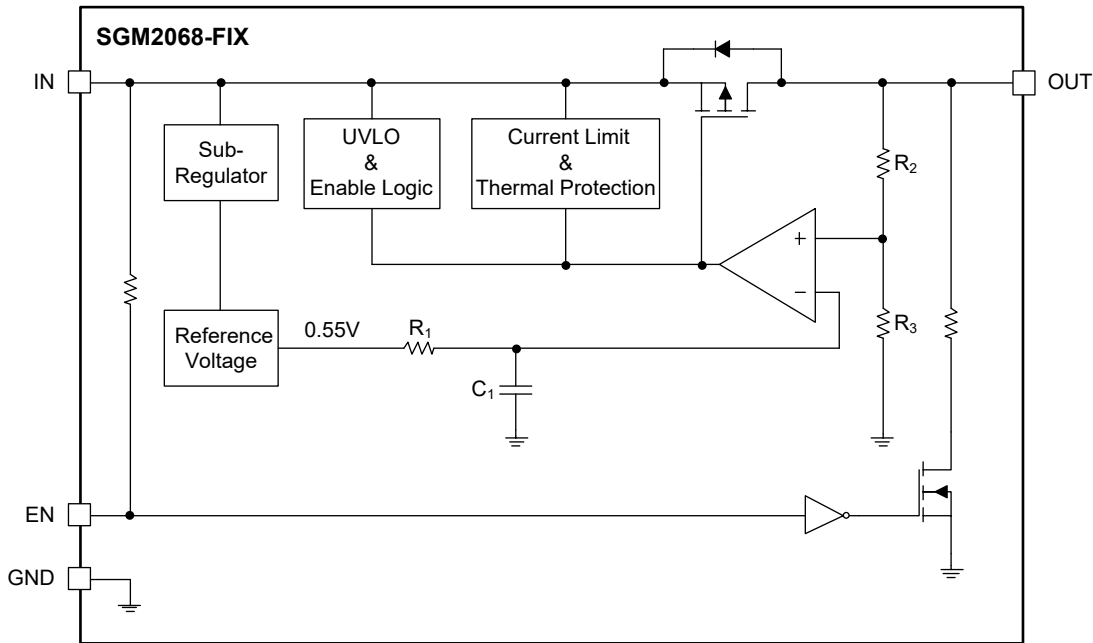

Figure 3. Block Diagram for Fixed Output Version

SGM2068

500mA, Fast Transient Response, Low Voltage, Low Noise and Low Dropout Linear Regulator

ELECTRICAL CHARACTERISTICS

($V_{IN} = (V_{OUT(NOM)} + 0.5V)$ or 1.5V (whichever is greater), $C_{IN} = 1\mu F$, $C_{OUT} = 1\mu F$, $T_J = -40^\circ C$ to $+125^\circ C$, typical values are at $T_J = +25^\circ C$, unless otherwise noted.)

PARAMETER	SYMBOL	CONDITIONS	MIN	TYP	MAX	UNITS	
Input Supply Voltage Range	V_{IN}		1.5		5.5	V	
Reference Voltage	V_{ADJ}	$V_{IN} = (V_{OUT(NOM)} + 0.5V)$ to 5.5V, $I_{OUT} = 10mA$	$T_J = +25^\circ C$	0.5445	0.55	0.5555	V
			$T_J = -40^\circ C$ to $+125^\circ C$	0.5401	0.55	0.5583	
Output Voltage Accuracy	V_{OUT}	$V_{IN} = (V_{OUT(NOM)} + 0.5V)$ to 5.5V, $I_{OUT} = 10mA$	$T_J = +25^\circ C$	-1		1	%
			$T_J = -40^\circ C$ to $+125^\circ C$	-1.8		1.5	
FB Pin Input Current	I_{ADJ}			0.1	50	nA	
Under-Voltage Lockout	V_{UVLO}	V_{IN} rising		1.35	1.43	V	
		V_{IN} falling	1.2	1.28			
Line Regulation	ΔV_{LNR}	$V_{IN} = (V_{OUT(NOM)} + 0.5V)$ to 5.5V, $I_{OUT} = 0.1mA$		2.5	15	mV	
Load Regulation	ΔV_{LDR}	$I_{OUT} = 0.1mA$ to 500mA		2.5	10	mV	
Dropout Voltage	V_{DROP}	$I_{OUT} = 500mA$, when V_{OUT} falls to $95\% \times V_{OUT(NOM)}$	$V_{OUT(NOM)} = 0.55V$		840	1000	mV
			$V_{OUT(NOM)} = 1.8V$		125	195	
			$V_{OUT(NOM)} = 3.3V$		70	115	
			$V_{OUT(NOM)} = 5.0V$		55	95	
Output Current Limit	I_{LIMIT}	$V_{IN} = (V_{OUT(NOM)} + 2V)$, $V_{OUT} = 90\% \times V_{OUT(NOM)}$	0.55	1.1		A	
Output Short-Circuit Current	I_{SHORT}	$V_{IN} = (V_{OUT(NOM)} + 2V)$, $V_{OUT} = 0V$		300		mA	
Quiescent Current	I_Q	$I_{OUT} = 0mA$		85	350	μA	
Shutdown Current	I_{SHDN}	$V_{EN} = 0V$		0.25	2.5	μA	
Enable Threshold Voltage	V_{IH}	EN input voltage high	1.0			V	
	V_{IL}	EN input voltage low			0.4		
Enable Input Current	I_{EN}	$V_{EN} = 0V$, $V_{IN} = 5.5V$		210	300	μA	
		$V_{EN} = 5.5V$, $V_{IN} = 5.5V$		0.01	1	μA	
Output Discharge Resistance	R_{DIS}	$V_{EN} = 0V$, $V_{IN} = 5.5V$		75		Ω	
Start-Up Time	t_{STR}	From assertion of V_{EN} to $V_{OUT} = 90\% \times V_{OUT(NOM)}$		450	830	μs	
Power Supply Rejection Ratio	PSRR	$V_{OUT} = 0.55V$, $V_{IN} = 1.5V$, Ripple 0.2V _{P-P} , $I_{OUT} = 50mA$, $C_{OUT} = 2.2\mu F$	$f = 1kHz$		50	dB	
			$f = 100kHz$		36		
			$f = 1MHz$		26		
		$V_{OUT} = 3.3V$, $V_{IN} = 3.8V$, Ripple 0.2V _{P-P} , $I_{OUT} = 50mA$, $C_{OUT} = 2.2\mu F$	$f = 1kHz$		60		
			$f = 100kHz$		41		
			$f = 1MHz$		28		
Output Voltage Noise	e_n	$V_{OUT} = 0.55V$, $V_{IN} = 1.5V$, $C_{OUT} = 2.2\mu F$, $f = 10Hz$ to 100kHz	$I_{OUT} = 1mA$		25	μV_{RMS}	
			$I_{OUT} = 500mA$		16		
		$V_{OUT} = 3.3V$, $V_{IN} = 3.8V$, $C_{OUT} = 2.2\mu F$, $f = 10Hz$ to 100kHz	$I_{OUT} = 1mA$		59		
			$I_{OUT} = 500mA$		54		
Thermal Shutdown Temperature	T_{SHDN}			155		$^\circ C$	
Thermal Shutdown Hysteresis	ΔT_{SHDN}			15		$^\circ C$	

SGM2068 500mA, Fast Transient Response, Low Voltage, Low Noise and Low Dropout Linear Regulator

TYPICAL PERFORMANCE CHARACTERISTICS

$T_J = +25^\circ\text{C}$, $V_{IN} = (V_{OUT(NOM)} + 0.5\text{V})$ or 1.5V (whichever is greater), $V_{EN} = V_{IN}$, $C_{IN} = 1\mu\text{F}$, $C_{OUT} = 1\mu\text{F}$, unless otherwise noted.

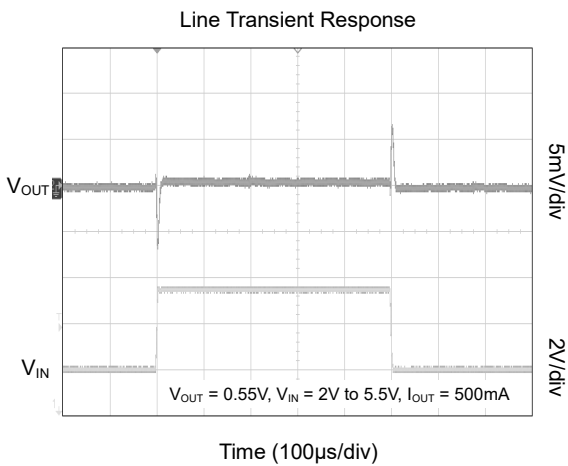
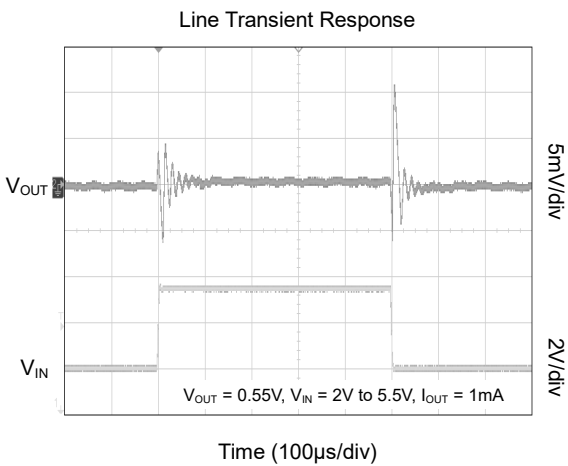
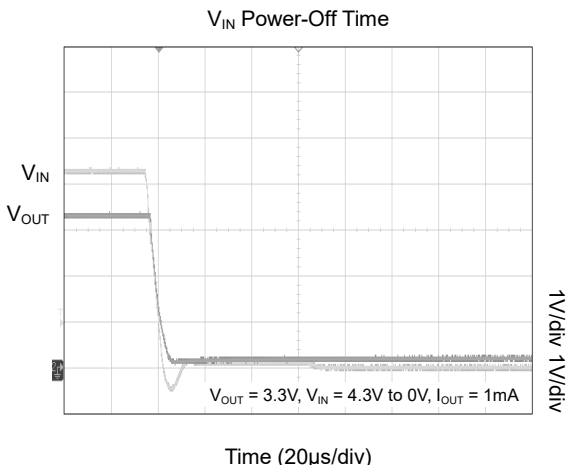
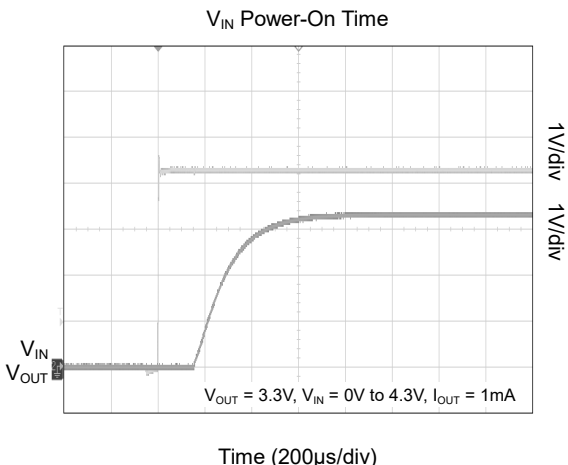
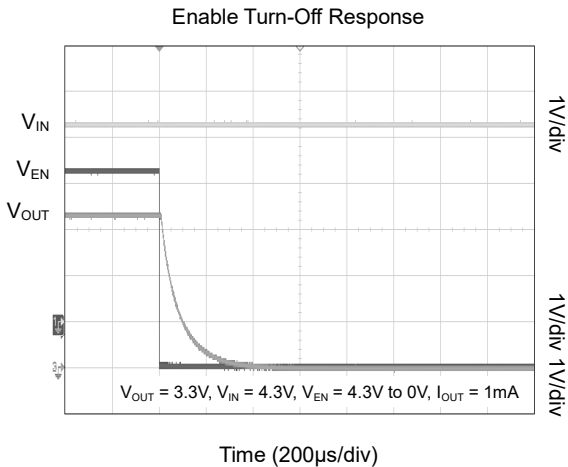
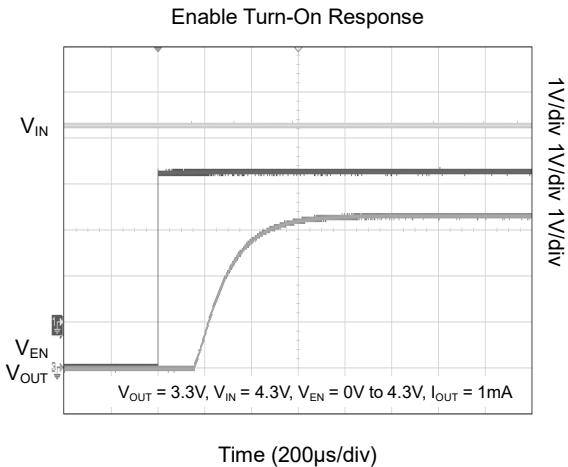

SGM2068 500mA, Fast Transient Response, Low Voltage, Low Noise and Low Dropout Linear Regulator

TYPICAL PERFORMANCE CHARACTERISTICS (continued)

$T_J = +25^\circ\text{C}$, $V_{IN} = (V_{OUT(NOM)} + 0.5\text{V})$ or 1.5V (whichever is greater), $V_{EN} = V_{IN}$, $C_{IN} = 1\mu\text{F}$, $C_{OUT} = 1\mu\text{F}$, unless otherwise noted.

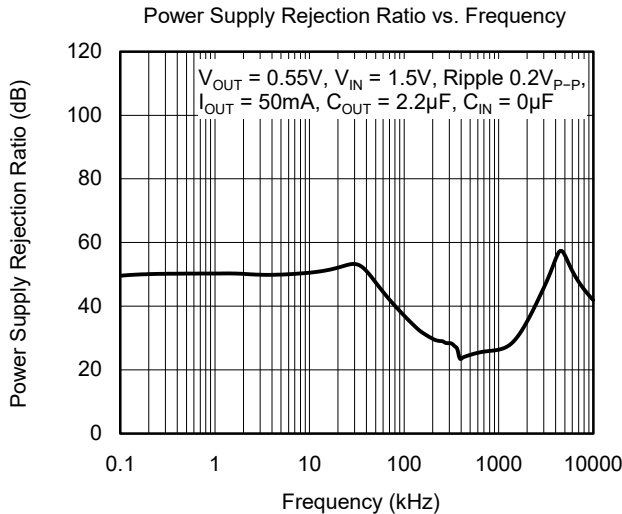
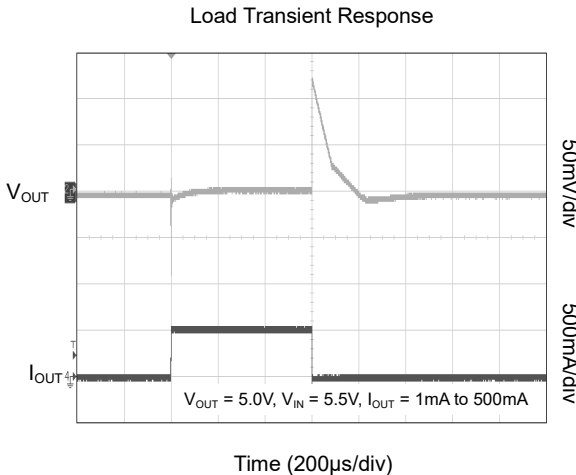
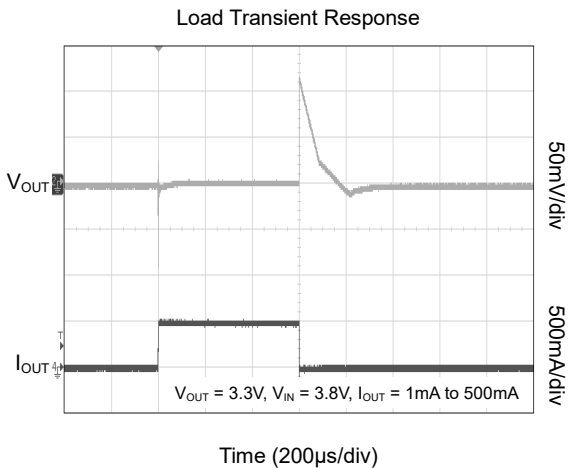
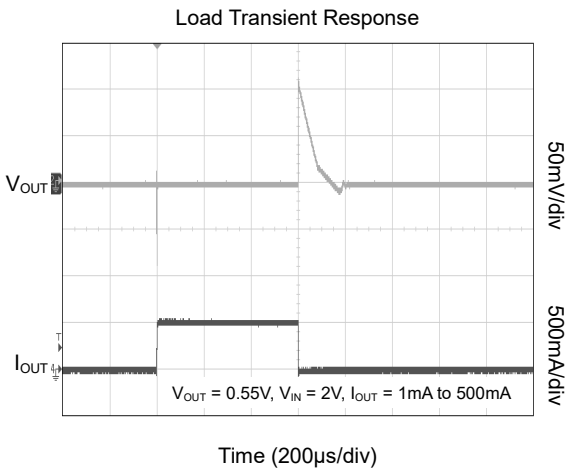
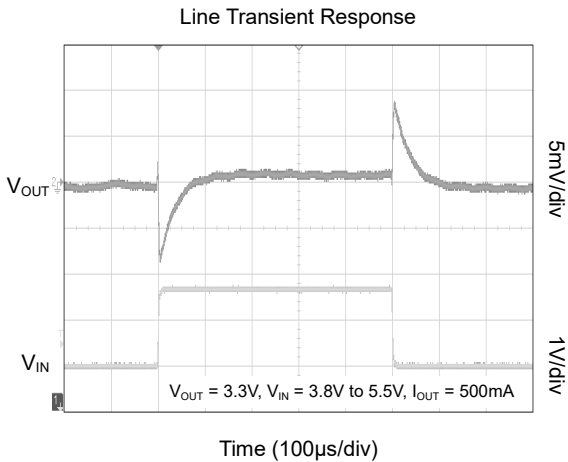
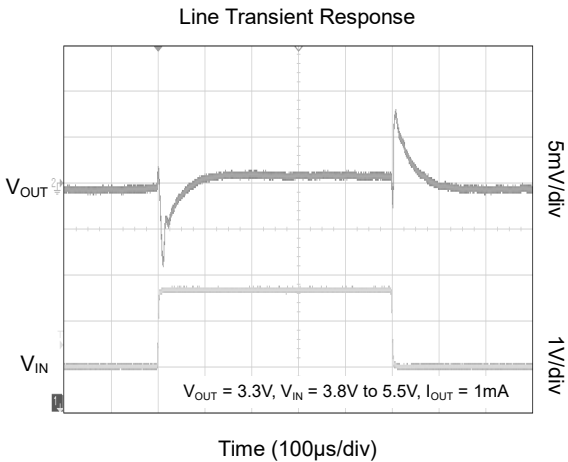

SGM2068 500mA, Fast Transient Response, Low Voltage, Low Noise and Low Dropout Linear Regulator

TYPICAL PERFORMANCE CHARACTERISTICS (continued)

$T_J = +25^\circ\text{C}$, $V_{IN} = (V_{OUT(NOM)} + 0.5\text{V})$ or 1.5V (whichever is greater), $V_{EN} = V_{IN}$, $C_{IN} = 1\mu\text{F}$, $C_{OUT} = 1\mu\text{F}$, unless otherwise noted.

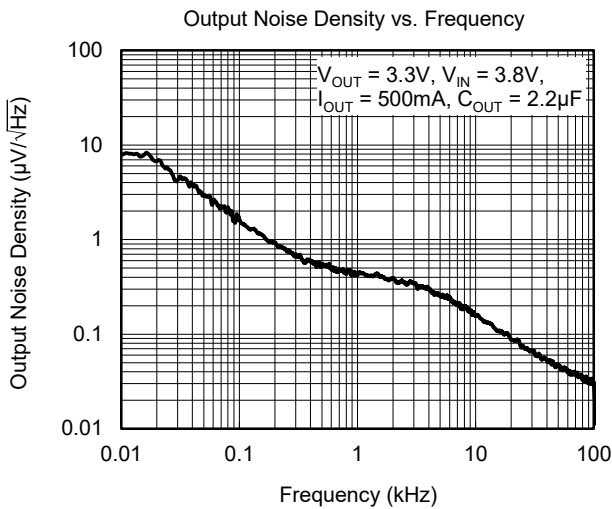
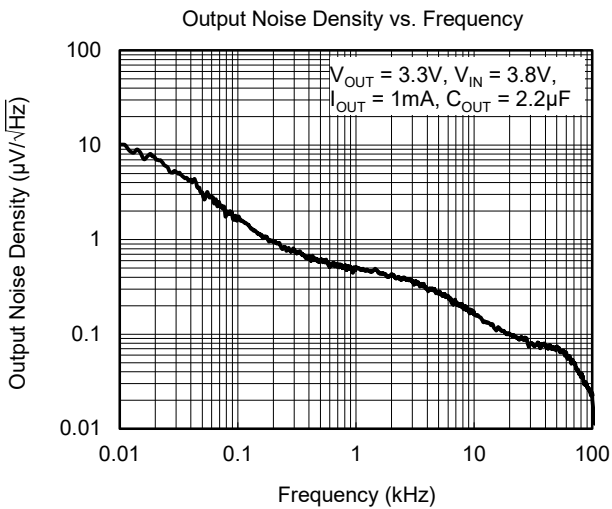
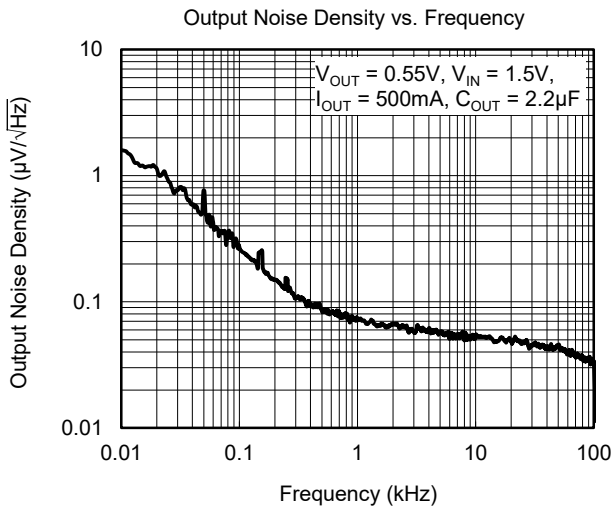
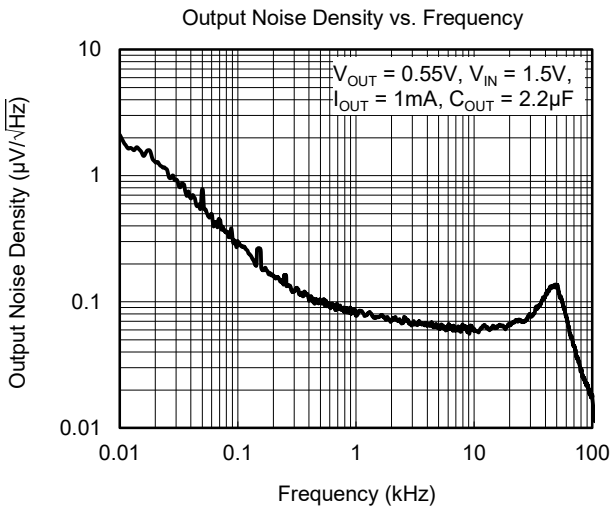
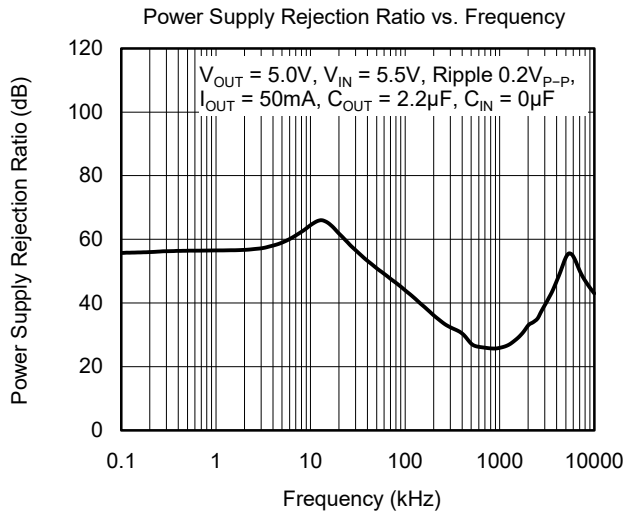
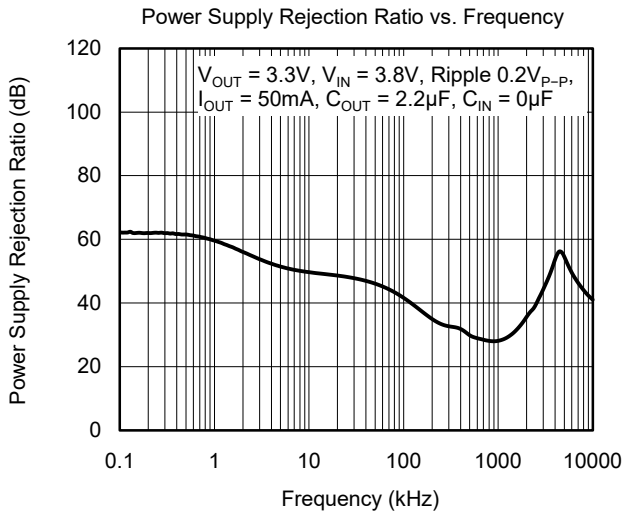

SGM2068 500mA, Fast Transient Response, Low Voltage, Low Noise and Low Dropout Linear Regulator

TYPICAL PERFORMANCE CHARACTERISTICS (continued)

$T_J = +25^\circ\text{C}$, $V_{IN} = (V_{OUT(NOM)} + 0.5\text{V})$ or 1.5V (whichever is greater), $V_{EN} = V_{IN}$, $C_{IN} = 1\mu\text{F}$, $C_{OUT} = 1\mu\text{F}$, unless otherwise noted.

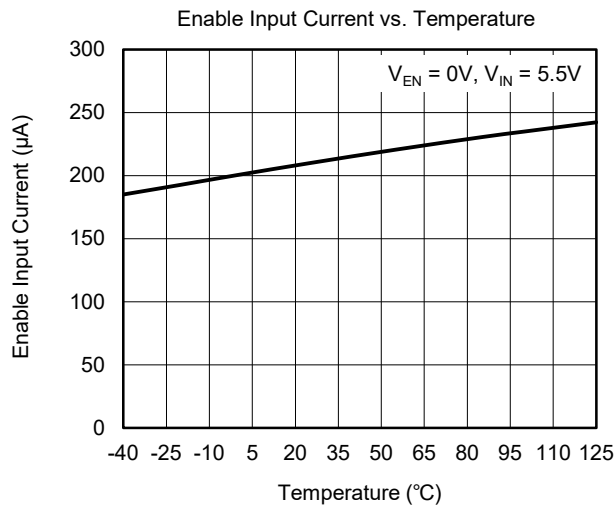
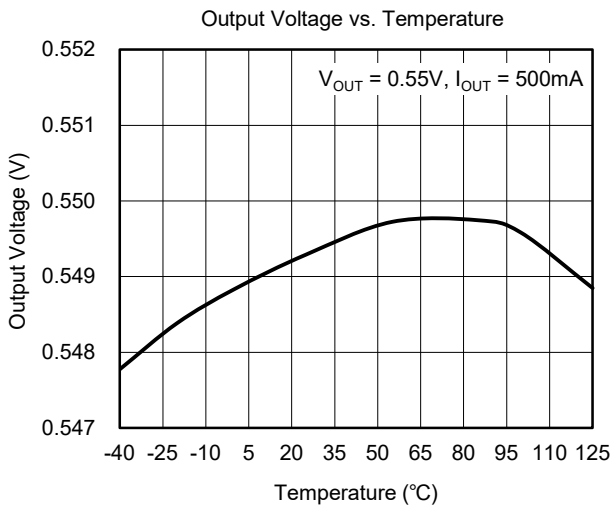
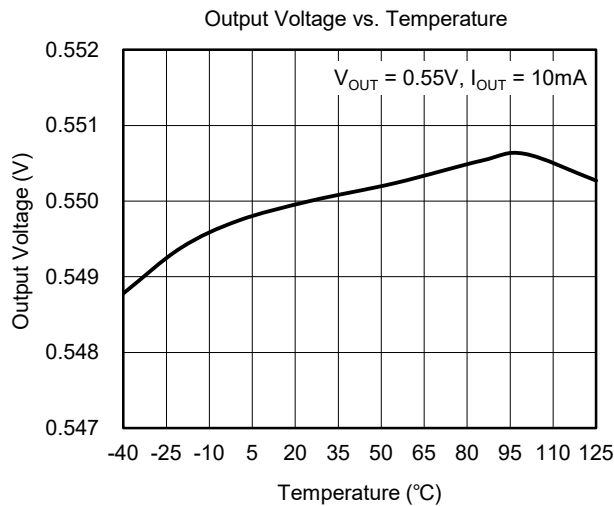
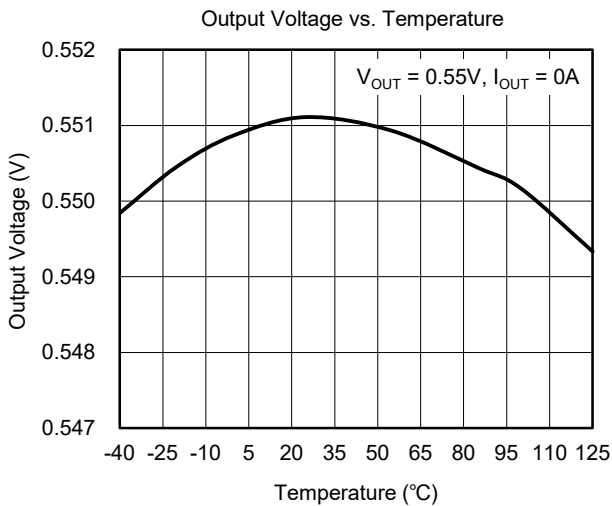
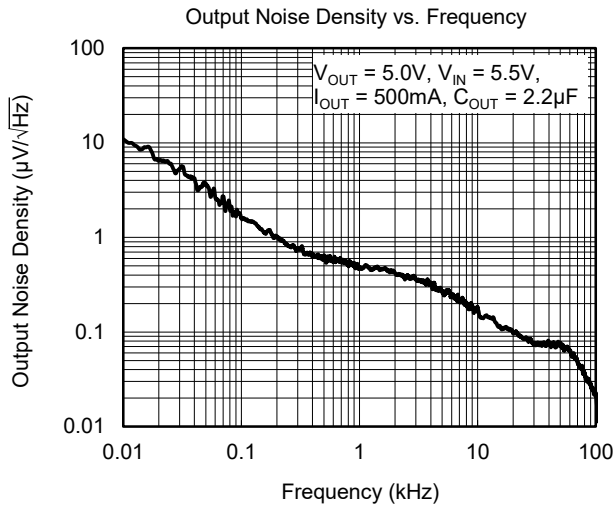
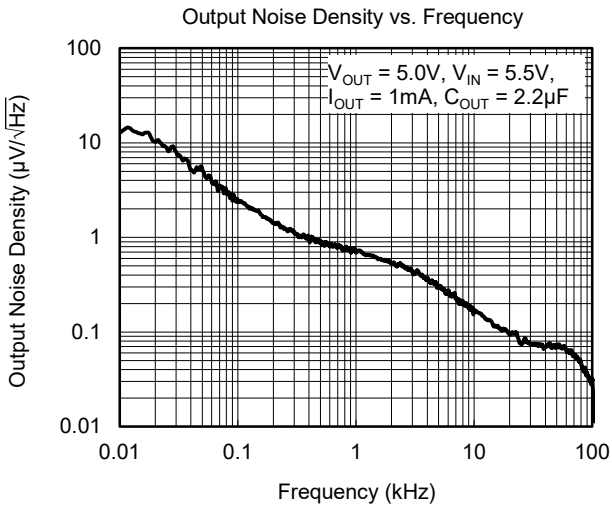

SGM2068 500mA, Fast Transient Response, Low Voltage, Low Noise and Low Dropout Linear Regulator

TYPICAL PERFORMANCE CHARACTERISTICS (continued)

$T_J = +25^\circ\text{C}$, $V_{IN} = (V_{OUT(NOM)} + 0.5\text{V})$ or 1.5V (whichever is greater), $V_{EN} = V_{IN}$, $C_{IN} = 1\mu\text{F}$, $C_{OUT} = 1\mu\text{F}$, unless otherwise noted.

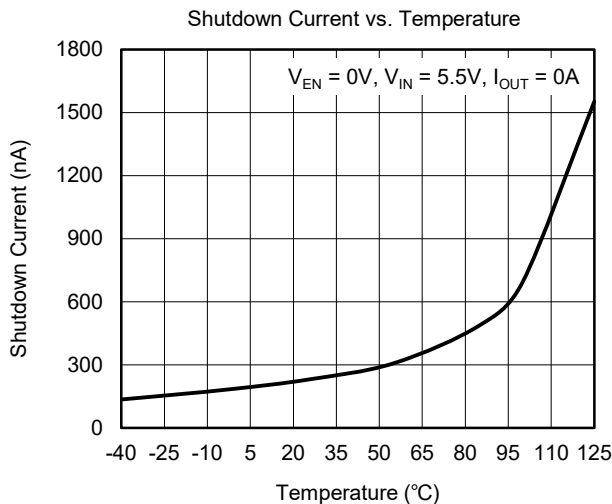
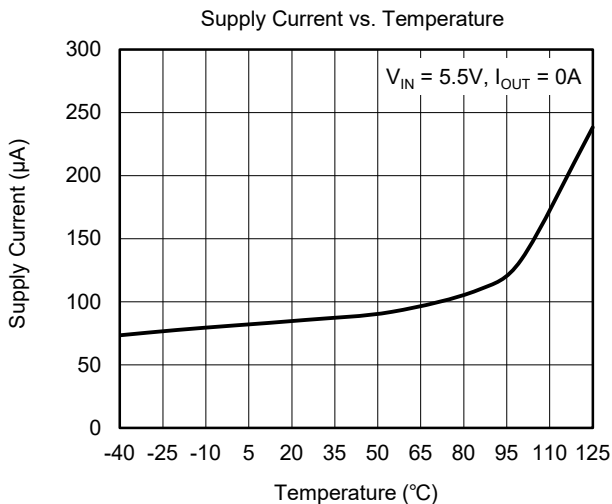
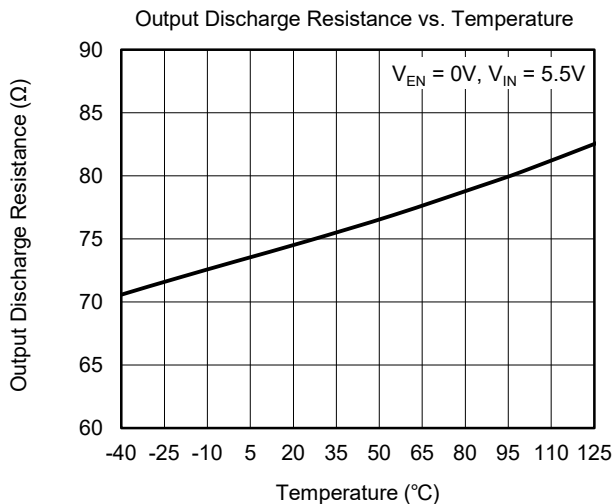
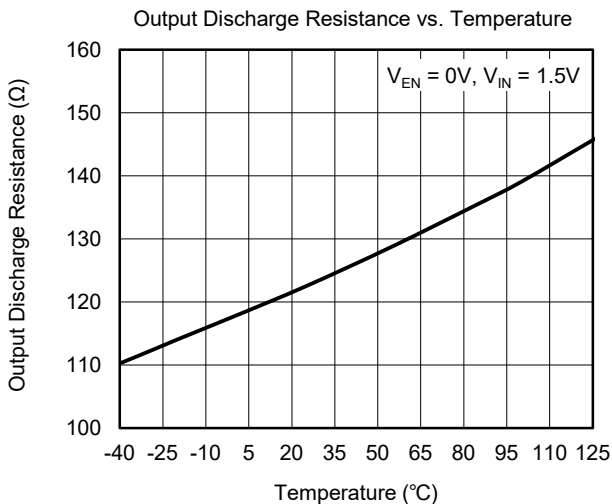
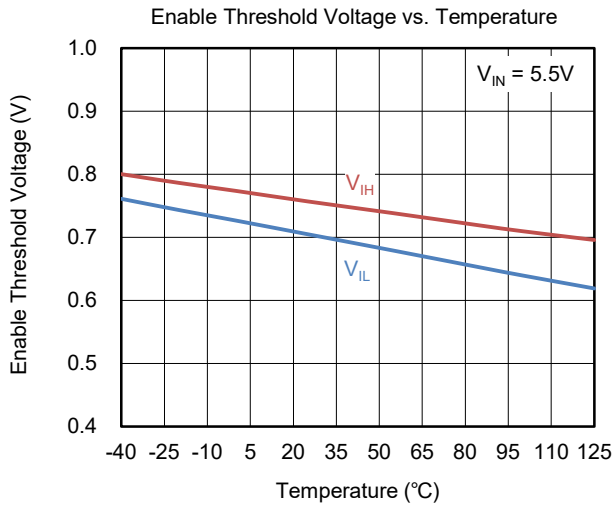
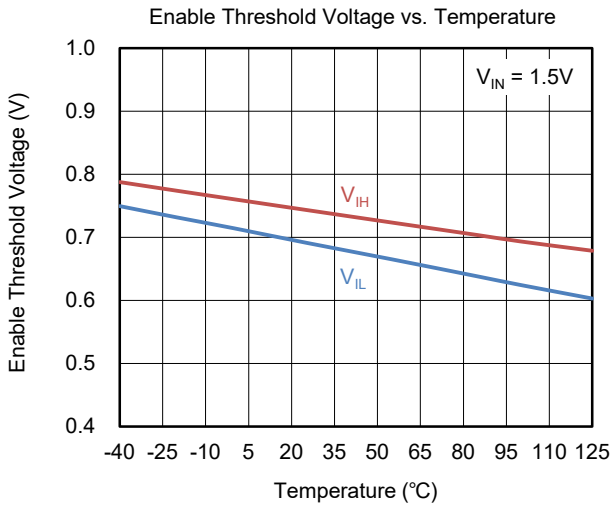

SGM2068 500mA, Fast Transient Response, Low Voltage, Low Noise and Low Dropout Linear Regulator

TYPICAL PERFORMANCE CHARACTERISTICS (continued)

$T_J = +25^\circ\text{C}$, $V_{IN} = (V_{OUT(NOM)} + 0.5\text{V})$ or 1.5V (whichever is greater), $V_{EN} = V_{IN}$, $C_{IN} = 1\mu\text{F}$, $C_{OUT} = 1\mu\text{F}$, unless otherwise noted.

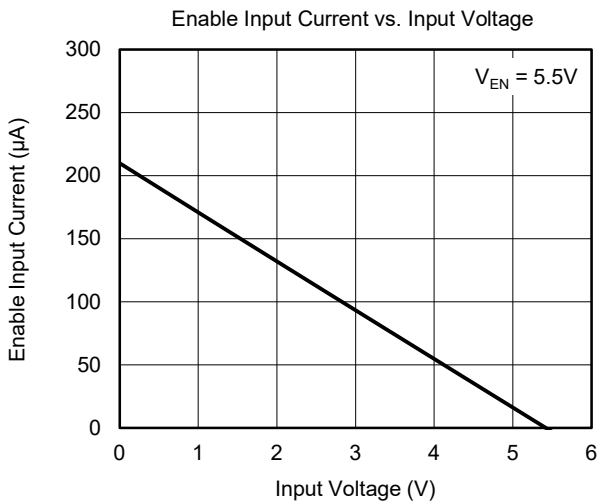
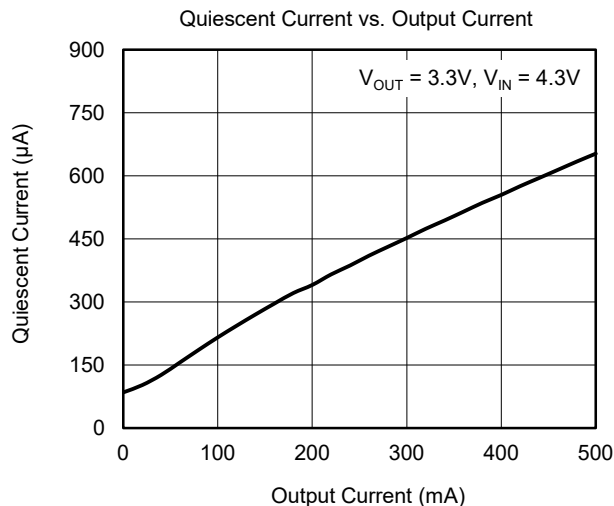
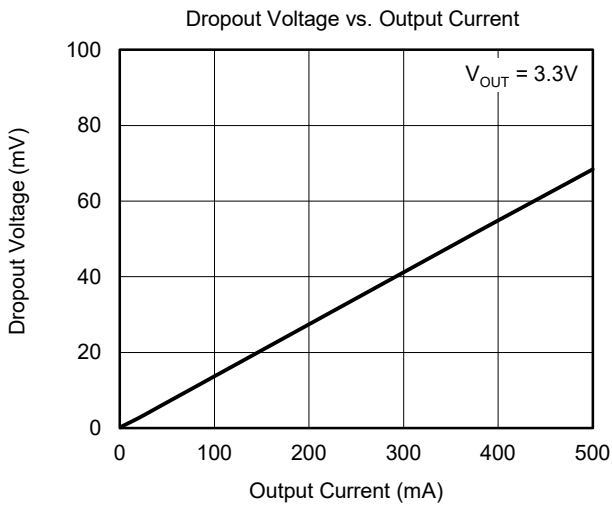
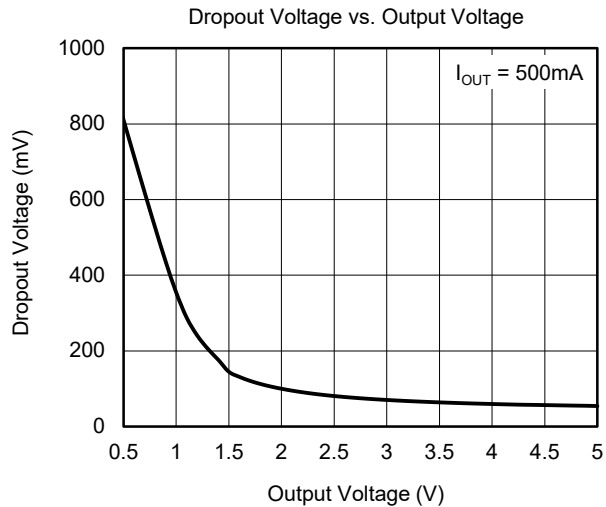
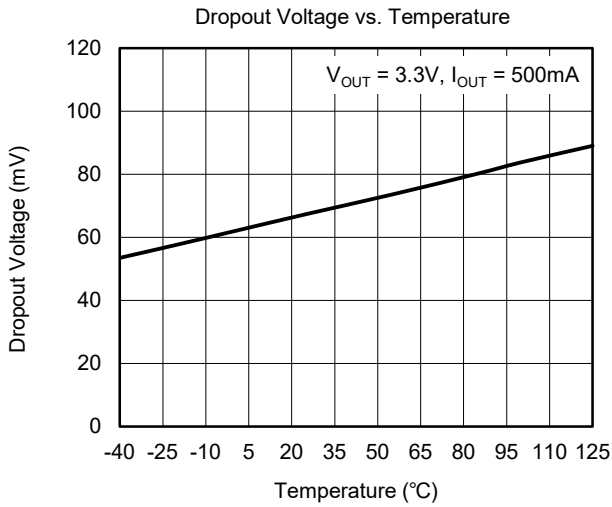

SGM2068 500mA, Fast Transient Response, Low Voltage, Low Noise and Low Dropout Linear Regulator

APPLICATION INFORMATION

The SGM2068 is a low noise and low dropout LDO and provides 500mA output current. These features make the device a reliable solution to solve many challenging problems in the generation of clean and accurate power supply. The high performance also makes the SGM2068 useful in a variety of applications. The SGM2068 provides protection functions for output overload, output short-circuit condition and overheating.

The SGM2068 provides an EN pin as an external chip enable control to enable/disable the device. When the regulator is in shutdown state, the shutdown current consumes as low as 0.25µA (TYP).

Input Capacitor Selection (C_{IN})

The input decoupling capacitor should be placed as close as possible to the IN pin to ensure the device stability. 1µF or larger X7R or X5R ceramic capacitor is selected to get good dynamic performance.

When V_{IN} is required to provide large current instantaneously, a large effective input capacitor is required. Multiple input capacitors can limit the input tracking inductance. Adding more input capacitors is available to restrict the ringing and to keep it below the device absolute maximum ratings.

Output Capacitor Selection (C_{OUT})

The output capacitor should be placed as close as possible to the OUT pin. 1µF or larger X7R or X5R ceramic capacitor is selected to get good dynamic performance. The minimum effective capacitance of C_{OUT} that SGM2068 can remain stable is 0.5µF. For ceramic capacitor, temperature, DC bias and package size will change the effective capacitance, so enough margin of C_{OUT} must be considered in design. Additionally, C_{OUT} with larger capacitance and lower ESR will help increase the high frequency PSRR and improve the load transient response.

Adjustable Regulator

The output voltage of the SGM2068-ADJ can be adjusted from 0.55V to 5.0V. The FB pin will be connected to two external resistors as shown in Figure 4. The output voltage is determined by the following equation:

$$V_{OUT} = V_{ADJ} \times \left(1 + \frac{R_1}{R_2}\right) \quad (1)$$

where:

V_{OUT} is output voltage and V_{ADJ} is the internal voltage reference, $V_{ADJ} = 0.55V$.

One parallel capacitor (C_{FF}) with R_1 can be used to improve the feedback loop stability and PSRR, increase the transient response and reduce the output noise. The resistance range of R_2 is recommended to be between 5kΩ and 130kΩ.

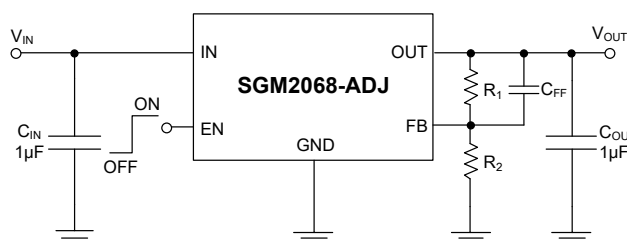

Figure 4. Adjustable Output Voltage Application

Enable Operation

The SGM2068 uses the EN pin to enable/disable the device and to deactivate/activate the output automatic discharge function. The EN pin has a 26kΩ (TYP) pull-up resistance to the power supply.

When the EN pin voltage is lower than 0.4V, the device is in shutdown state. There is no current flowing from IN to OUT pins. In this state, the automatic discharge transistor is active to discharge the output voltage through a 75Ω (TYP) resistor.

When the EN pin voltage is higher than 1.0V or the EN pin is floated, the device is in active state. The output voltage is regulated to the expected value and the automatic discharge transistor is turned off.

Under-Voltage Lockout (UVLO)

The UVLO circuit monitors the input voltage to prevent the device from turning on before V_{IN} rises above the V_{UVLO} threshold. The UVLO circuit responds quickly to glitches on the IN pin and attempts to disable the output of the device if any of these rails collapses. The local input capacitance prevents severe brownouts in most applications.

APPLICATION INFORMATION (continued)

Reverse Current Protection

The PMOS power transistor has an inherent body diode. This body diode will be forward biased when $V_{OUT} > V_{IN}$. When $V_{OUT} > V_{IN}$, the reverse current flowing from the OUT pin to the IN pin will damage the SGM2068. If $V_{OUT} > V_{IN}$ event would happen in system, one external Schottky diode will be added between OUT pin and IN pin in circuit design to protect the SGM2068.

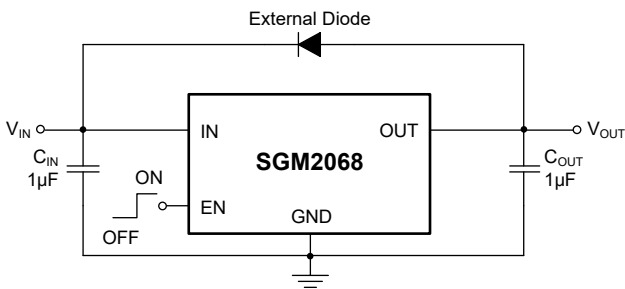

Figure 5. Reverse Protection Reference Design

Output Current Limit and Short-Circuit Protection

When overload events happen, the output current is internally limited to 1.1A (TYP). When the OUT pin is shorted to ground, the short-circuit protection will limit the output current to 300mA (TYP).

Thermal Shutdown

When the die temperature exceeds the threshold value of thermal shutdown, the SGM2068 will be in shutdown state and it will remain in this state until the die temperature decreases to +140°C.

Power Dissipation (PD)

Power dissipation (P_D) of the SGM2068 can be calculated by the equation $P_D = (V_{IN} - V_{OUT}) \times I_{OUT}$. The maximum allowable power dissipation ($P_{D(MAX)}$) of the SGM2068 is affected by many factors, including the difference between junction temperature and ambient temperature ($T_{J(MAX)} - T_A$), package thermal resistance from the junction to the ambient environment (θ_{JA}), the rate of ambient airflow and PCB layout. $P_{D(MAX)}$ can be approximated by the following equation:

$$P_{D(MAX)} = (T_{J(MAX)} - T_A) / \theta_{JA} \tag{2}$$

REVISION HISTORY

NOTE: Page numbers for previous revisions may differ from page numbers in the current version.

Changes from Original (DECEMBER 2023) to REV.A	Page
Changed from product preview to production data.....	All

PACKAGE OUTLINE DIMENSIONS

SOT-23-5

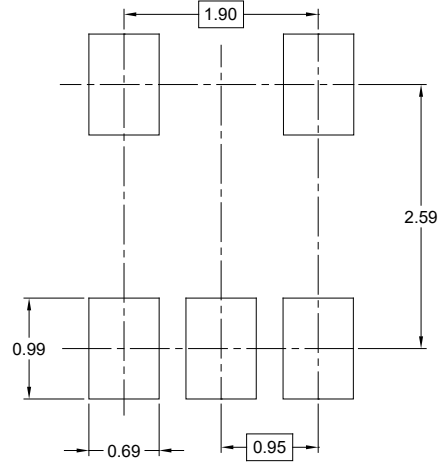
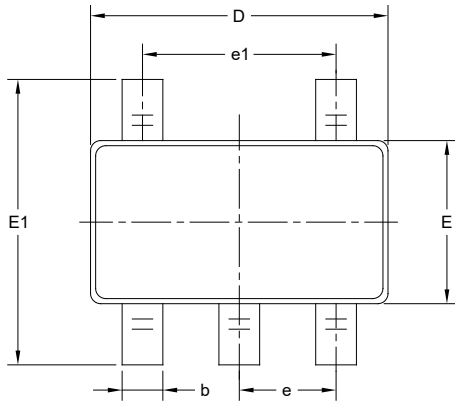

RECOMMENDED LAND PATTERN (Unit: mm)

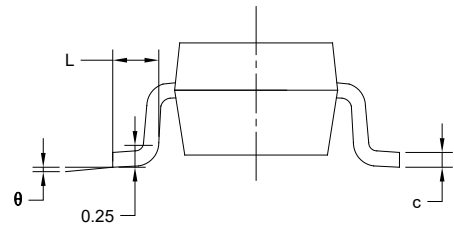
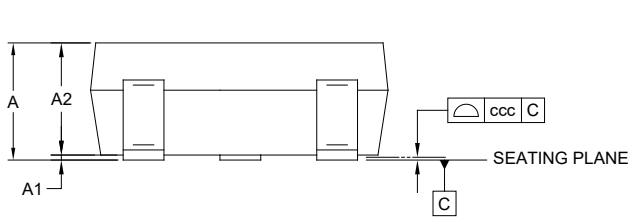

Symbol	Dimensions In Millimeters		
	MIN	MOD	MAX
A	-	-	1.450
A1	0.000	-	0.150
A2	0.900	-	1.300
b	0.300	-	0.500
c	0.080	-	0.220
D	2.750	-	3.050
E	1.450	-	1.750
E1	2.600	-	3.000
e	0.950 BSC		
e1	1.900 BSC		
L	0.300	-	0.600
θ	0°	-	8°
ccc	0.100		

NOTES:

1. This drawing is subject to change without notice.
2. The dimensions do not include mold flashes, protrusions or gate burrs.
3. Reference JEDEC MO-178.

PACKAGE OUTLINE DIMENSIONS

TDFN-2x2-6AL

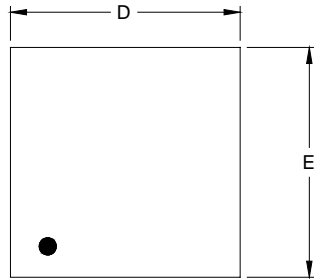

TOP VIEW

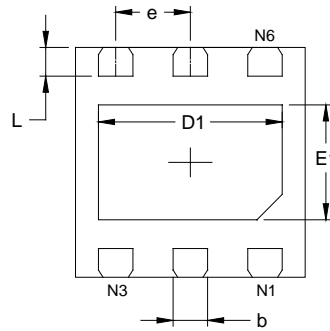

BOTTOM VIEW

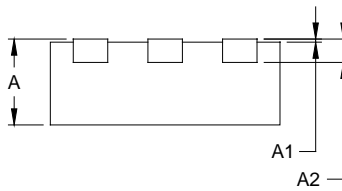

SIDE VIEW

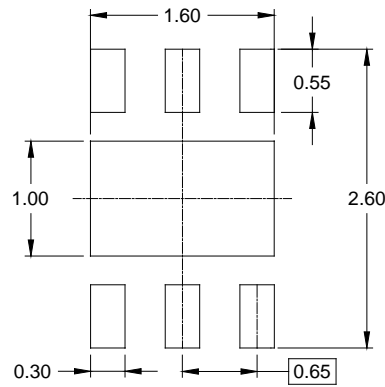

RECOMMENDED LAND PATTERN (Unit: mm)

Symbol	Dimensions In Millimeters		Dimensions In Inches	
	MIN	MAX	MIN	MAX
A	0.700	0.800	0.028	0.031
A1	0.000	0.050	0.000	0.002
A2	0.203 REF		0.008 REF	
D	1.900	2.100	0.075	0.083
D1	1.500	1.700	0.059	0.067
E	1.900	2.100	0.075	0.083
E1	0.900	1.100	0.035	0.043
b	0.250	0.350	0.010	0.014
e	0.650 BSC		0.026 BSC	
L	0.174	0.326	0.007	0.013

NOTE: This drawing is subject to change without notice.

TAPE AND REEL INFORMATION

REEL DIMENSIONS



TAPE DIMENSIONS



NOTE: The picture is only for reference. Please make the object as the standard.

KEY PARAMETER LIST OF TAPE AND REEL

Package Type	Reel Diameter	Reel Width W1 (mm)	A0 (mm)	B0 (mm)	K0 (mm)	P0 (mm)	P1 (mm)	P2 (mm)	W (mm)	Pin1 Quadrant
SOT-23-5	7"	9.5	3.20	3.20	1.40	4.0	4.0	2.0	8.0	Q3
TDFN-2×2-6AL	7"	9.5	2.30	2.30	1.10	4.0	4.0	2.0	8.0	Q2

000001

PACKAGE INFORMATION

CARTON BOX DIMENSIONS



NOTE: The picture is only for reference. Please make the object as the standard.

KEY PARAMETER LIST OF CARTON BOX

Reel Type	Length (mm)	Width (mm)	Height (mm)	Pizza/Carton
7" (Option)	368	227	224	8
7"	442	410	224	18

DD0002