

RF4E075AT

Pch -30V -7.5A Middle Power MOSFET

V_{DSS}	-30V
$R_{DS(on)}(Max.)$	21.7m Ω
I_D	$\pm 7.5A$
P_D	2W

●Features

- 1) Low on - resistance.
- 2) High Power small mold Package (HUML2020L8).
- 3) Pb-free lead plating ; RoHS compliant.
- 4) Halogen Free.

●Application

Switching
Load switch

●Absolute maximum ratings ($T_a = 25^\circ C$)

Parameter	Symbol	Value	Unit
Drain - Source voltage	V_{DSS}	-30	V
Continuous drain current	I_D	± 7.5	A
Pulsed drain current	$I_{D,pulse}^{*1}$	± 30	A
Gate - Source voltage	V_{GSS}	± 20	V
Avalanche energy, single pulse	E_{AS}^{*2}	10.6	mJ
Avalanche current	I_{AS}^{*2}	-2.7	A
Power dissipation	P_D^{*3}	2	W
Junction temperature	T_j	150	$^\circ C$
Range of storage temperature	T_{stg}	-55 to +150	$^\circ C$

●Outline

HUML2020L8

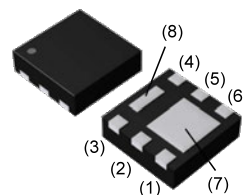

●Inner circuit

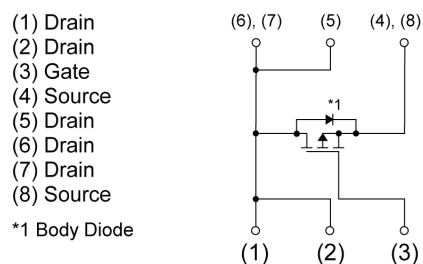

●Packaging specifications

Type	Packing	Embossed Tape
	Reel size (mm)	180
	Tape width (mm)	8
	Basic ordering unit (pcs)	3000
	Taping code	TCR
	Marking	JT

● Thermal resistance

Parameter	Symbol	Values			Unit
		Min.	Typ.	Max.	
Thermal resistance, junction - ambient	R_{thJA}^{*3}	-	-	62.5	°C/W

● Electrical characteristics ($T_a = 25^\circ\text{C}$)

Parameter	Symbol	Conditions	Values			Unit
			Min.	Typ.	Max.	
Drain - Source breakdown voltage	$V_{(BR)DSS}$	$V_{GS} = 0V, I_D = -1mA$	-30	-	-	V
Breakdown voltage temperature coefficient	$\frac{\Delta V_{(BR)DSS}}{\Delta T_j}$	$I_D = -1mA$ referenced to 25°C	-	-22	-	mV/°C
Zero gate voltage drain current	I_{DSS}	$V_{DS} = -30V, V_{GS} = 0V$	-	-	-1	μA
Gate - Source leakage current	I_{GSS}	$V_{GS} = \pm 20V, V_{DS} = 0V$	-	-	± 100	nA
Gate threshold voltage	$V_{GS(th)}$	$V_{DS} = V_{GS}, I_D = -1mA$	-1.0	-	-2.5	V
Gate threshold voltage temperature coefficient	$\frac{\Delta V_{GS(th)}}{\Delta T_j}$	$I_D = -1mA$ referenced to 25°C	-	2.9	-	mV/°C
Static drain - source on - state resistance	$R_{DS(on)}^{*4}$	$V_{GS} = -10V, I_D = -7.5A$	-	16.7	21.7	m Ω
		$V_{GS} = -4.5V, I_D = -7.5A$	-	24.4	31.7	
Forward Transfer Admittance	$ Y_{fs} ^{*4}$	$V_{DS} = -5.0V, I_D = -7.5A$	6.5	-	-	S

*1 $P_w \leq 10\mu\text{s}$, Duty cycle $\leq 1\%$

*2 $Tr1: L \approx 2mH, V_{DD} = -15V, R_G = 25\Omega$, STARTING $T_{ch} = 25^\circ\text{C}$ Fig.3-1,3-2

*3 MOUNTED ON 40mm×40mm Cu BOARD

*4 Pulsed

● Electrical characteristics ($T_a = 25^\circ\text{C}$)

Parameter	Symbol	Conditions	Values			Unit
			Min.	Typ.	Max.	
Input capacitance	C_{iss}	$V_{GS} = 0V$	-	1000	-	pF
Output capacitance	C_{oss}	$V_{DS} = -15V$	-	180	-	
Reverse transfer capacitance	C_{rss}	$f = 1\text{MHz}$	-	140	-	
Turn - on delay time	$t_{d(on)}^{*4}$	$V_{DD} \approx -15V, V_{GS} = -10V$	-	10	-	ns
Rise time	t_r^{*4}	$I_D = -3.75A$	-	18	-	
Turn - off delay time	$t_{d(off)}^{*4}$	$R_L \approx 4\Omega$	-	60	-	
Fall time	t_f^{*4}	$R_G = 10\Omega$	-	35	-	

● Gate charge characteristics ($T_a = 25^\circ\text{C}$)

Parameter	Symbol	Conditions	Values			Unit	
			Min.	Typ.	Max.		
Total gate charge	Q_g^{*4}	$V_{DD} \approx -15V$ $I_D = -7.5A$	$V_{GS} = -10V$	-	22	-	nC
Gate - Source charge	Q_{gs}^{*4}		$V_{GS} = -4.5V$	-	11	-	
Gate - Drain charge	Q_{gd}^{*4}			-	3.4	-	
				-	4.2	-	

● Body diode electrical characteristics (Source-Drain) ($T_a = 25^\circ\text{C}$)

Parameter	Symbol	Conditions	Values			Unit
			Min.	Typ.	Max.	
Body diode continuous forward current	I_S	$T_a = 25^\circ\text{C}$	-	-	-1.67	A
Body diode pulse current	I_{SP}^{*1}		-	-	-30	A
Forward voltage	V_{SD}^{*4}	$V_{GS} = 0V, I_S = -1.67A$	-	-	-1.2	V

● Electrical characteristic curves

Fig.1 Power Dissipation Derating Curve

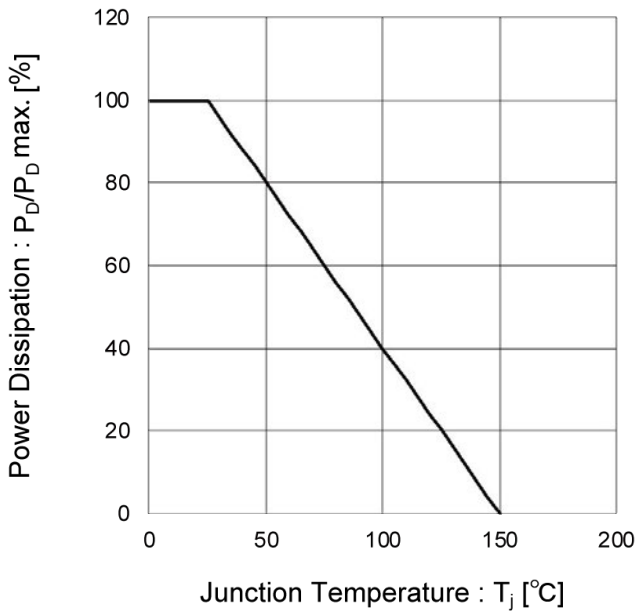

Fig.2 Maximum Safe Operating Area

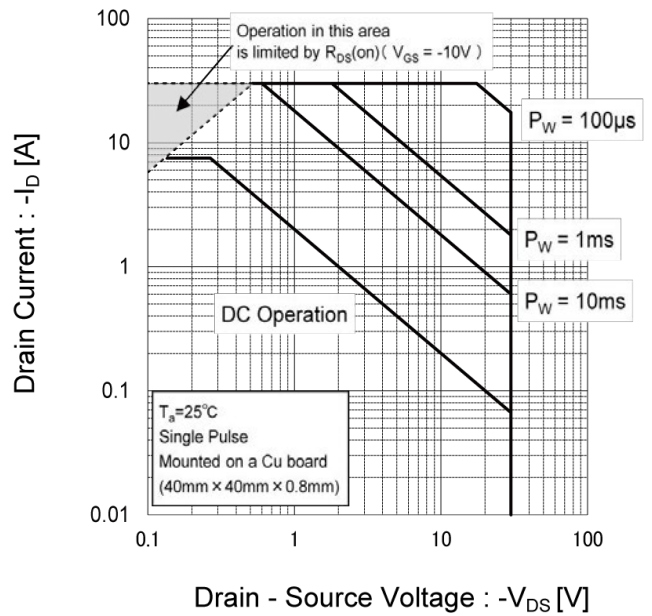

Fig.3 Normalized Transient Thermal Resistance vs. Pulse Width

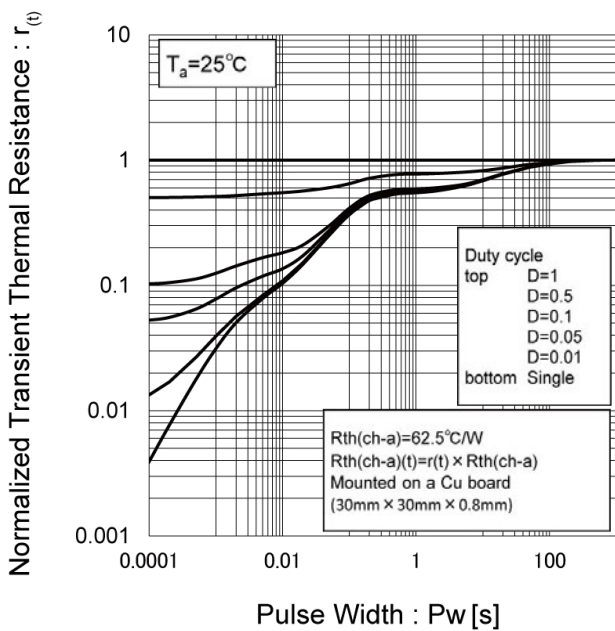
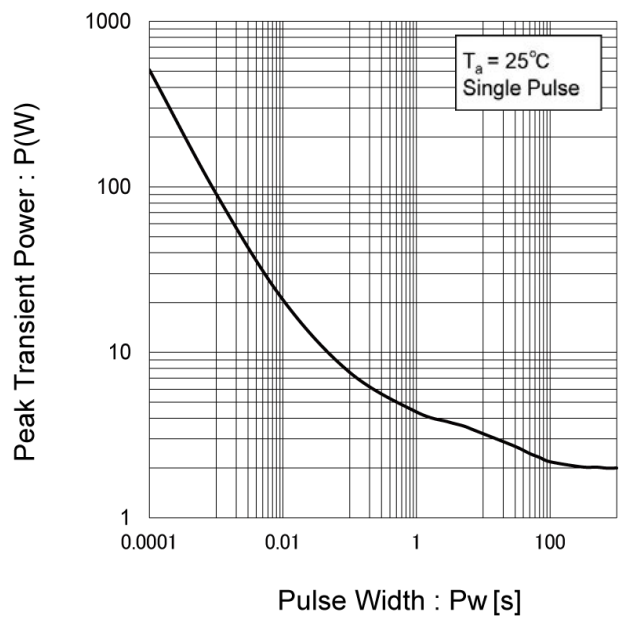

Fig.4 Single Pulse Maximum Power dissipation



● Electrical characteristic curves

Fig.5 Typical Output Characteristics(I)

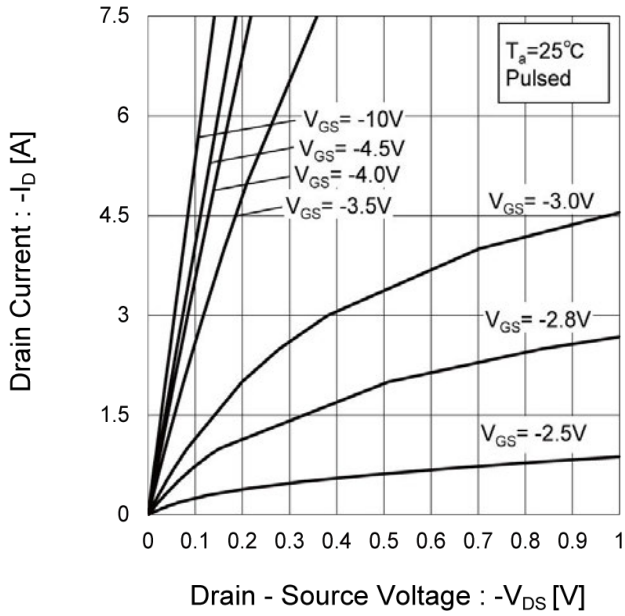

Fig.6 Typical Output Characteristics(II)

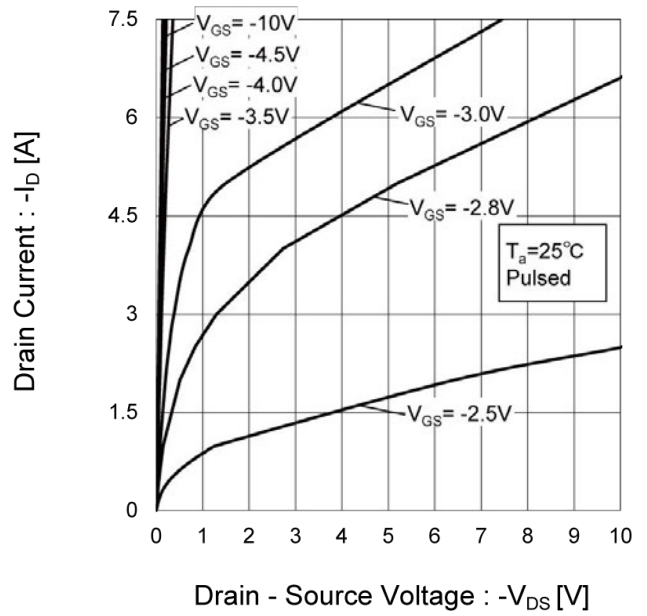
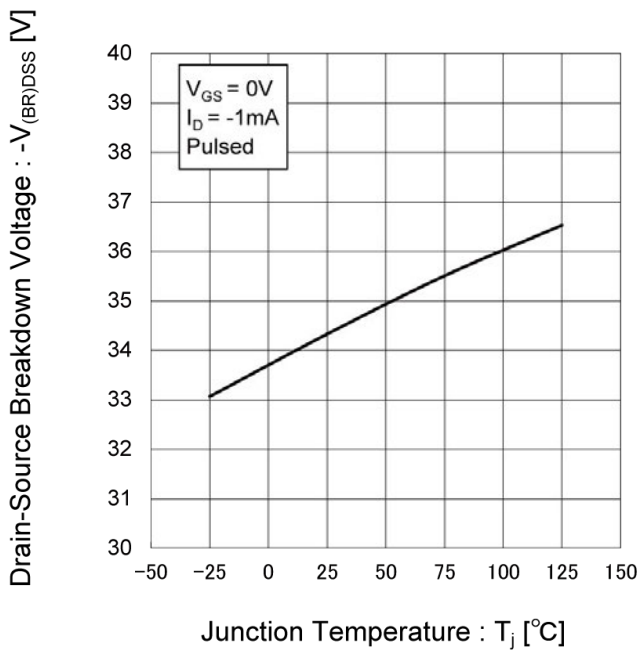

Fig.7 Breakdown Voltage vs. Junction Temperature



● Electrical characteristic curves

Fig.8 Typical Transfer Characteristics

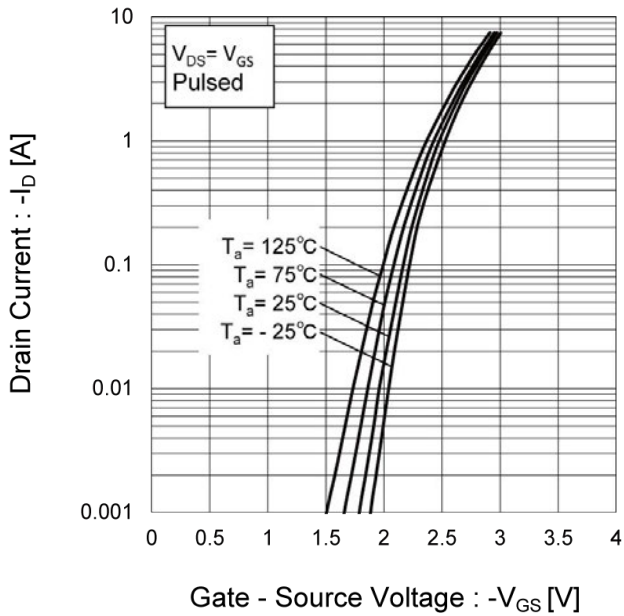

Fig.9 Gate Threshold Voltage vs. Junction Temperature

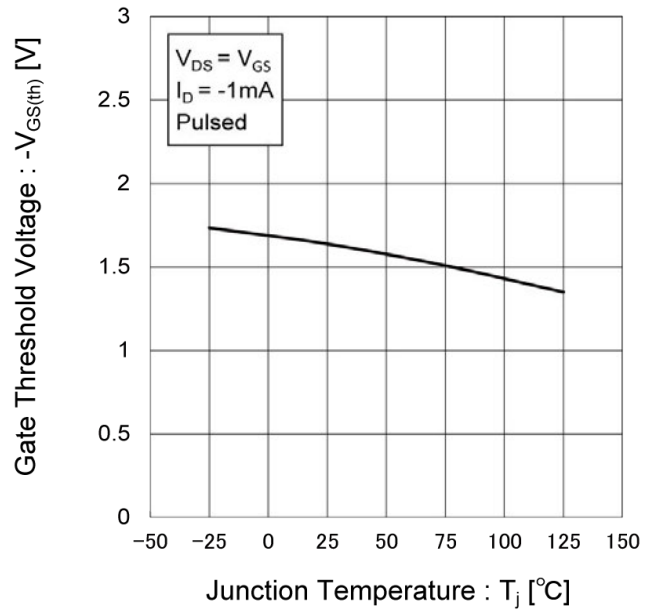
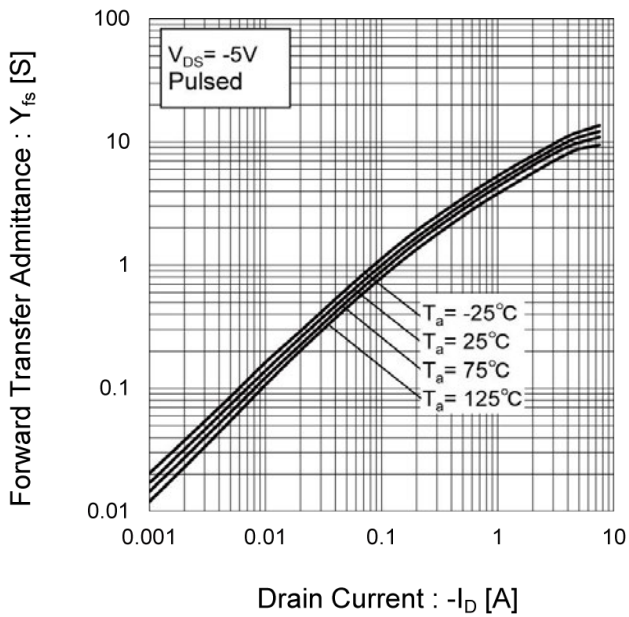

Fig.10 Transconductance vs. Drain Current



● Electrical characteristic curves

Fig.11 Drain Current Derating Curve

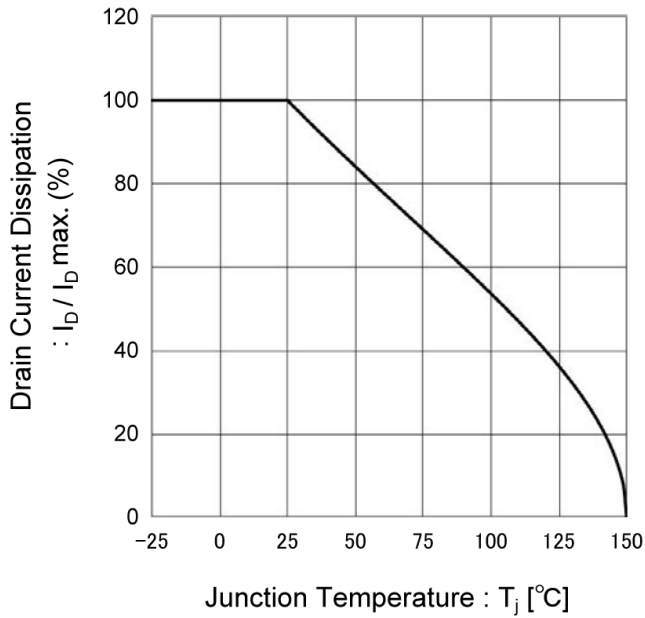

Fig.12 Static Drain - Source On - State Resistance vs. Gate Source Voltage

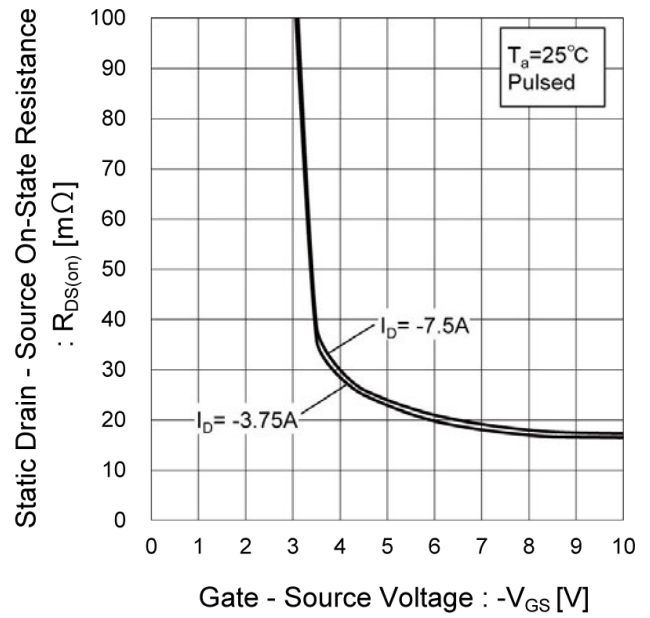
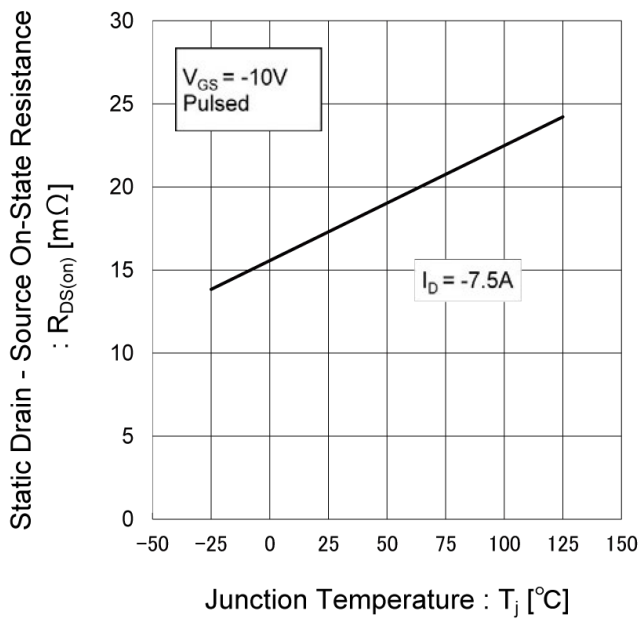

Fig.13 Static Drain - Source On - State Resistance vs. Junction Temperature



● Electrical characteristic curves

Fig.14 Static Drain - Source On - State Resistance vs. Drain Current(I)

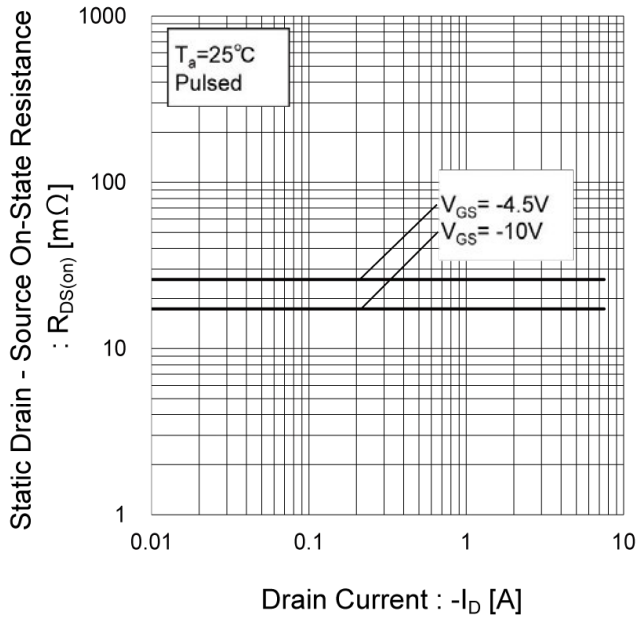

Fig.15 Static Drain - Source On - State Resistance vs. Drain Current(II)

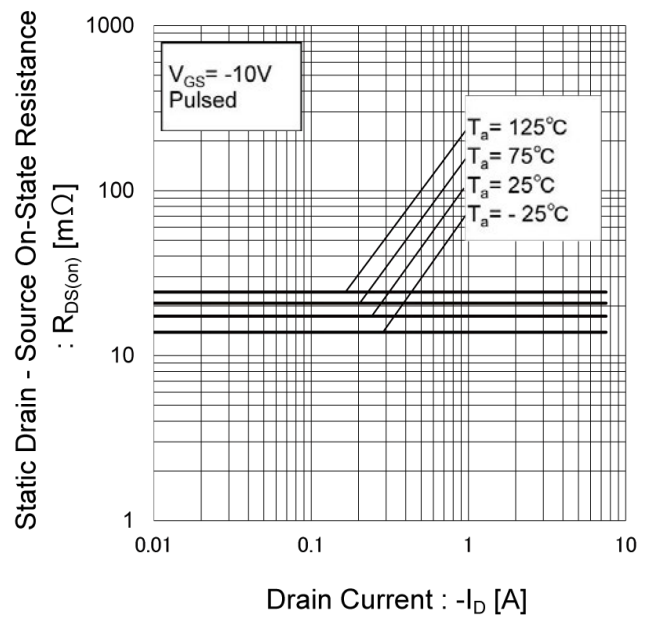
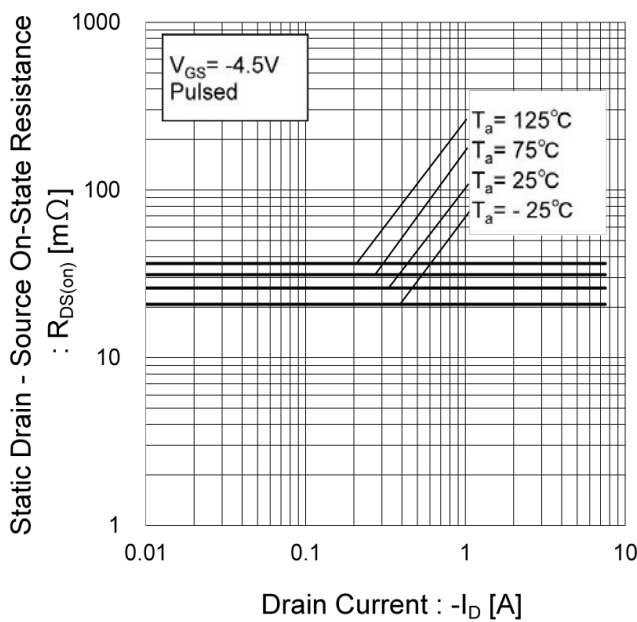

Fig.16 Static Drain - Source On - State Resistance vs. Drain Current(III)



● Electrical characteristic curves

Fig.17 Typical Capacitance vs. Drain - Source Voltage

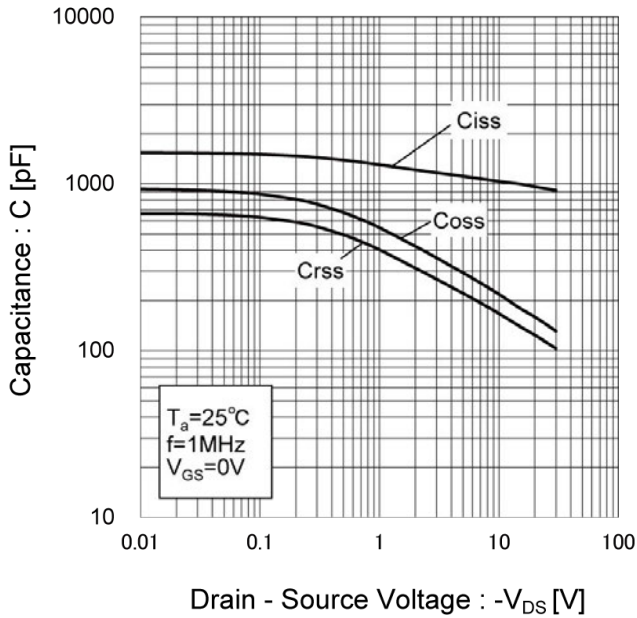

Fig.18 Switching Characteristics

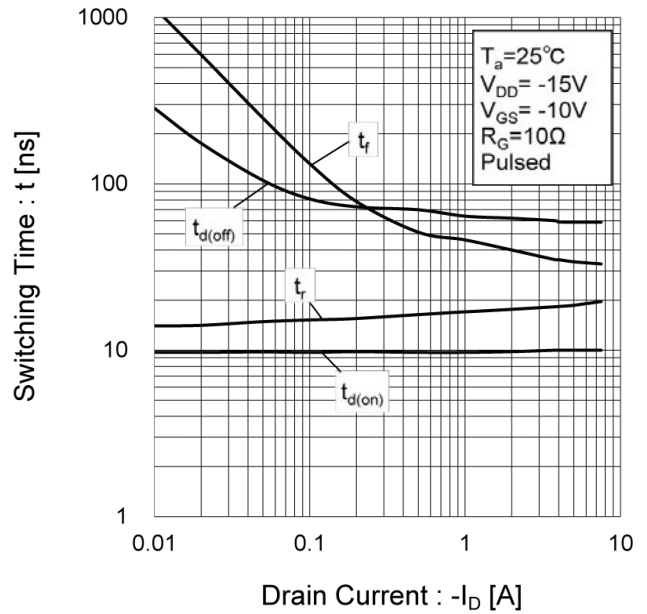

Fig.19 Dynamic Input Characteristics

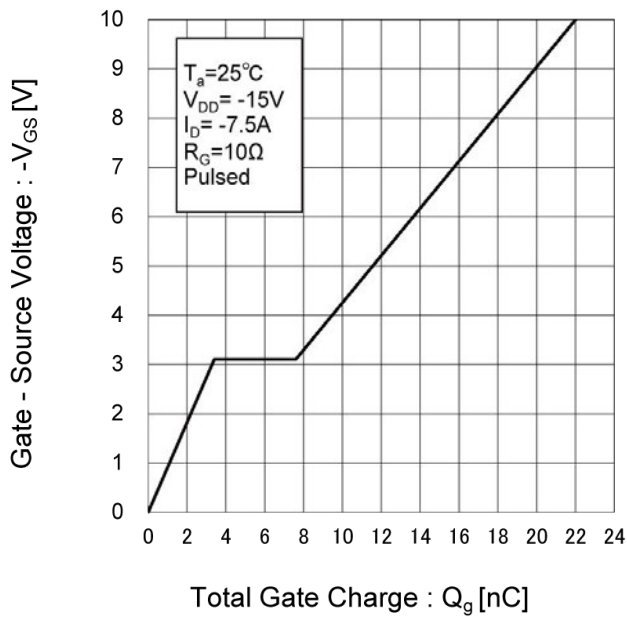
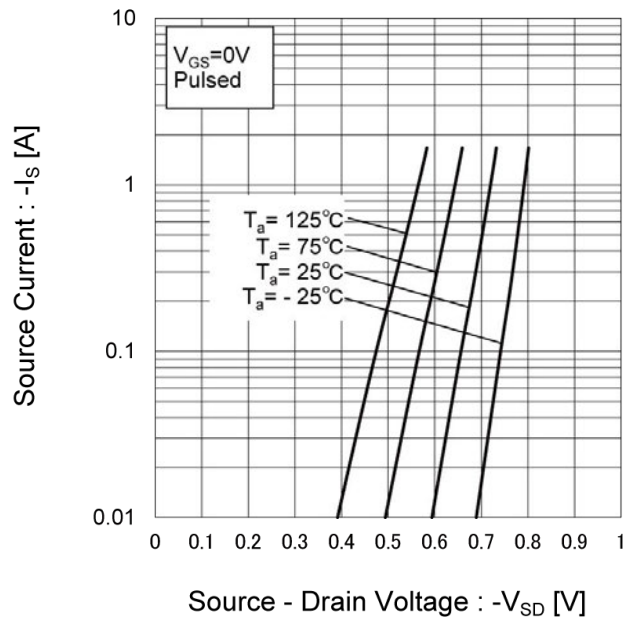

Fig.20 Source Current vs. Source Drain Voltage



● Measurement circuits

Fig.1-1 Switching Time Measurement Circuit

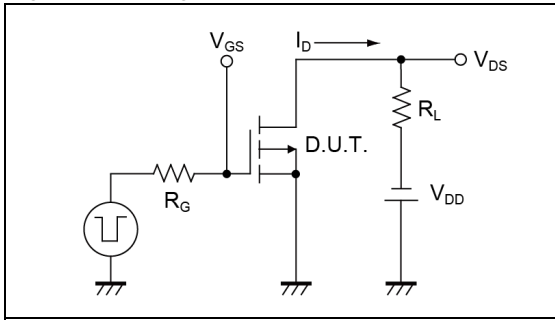

Fig.1-2 Switching Waveforms

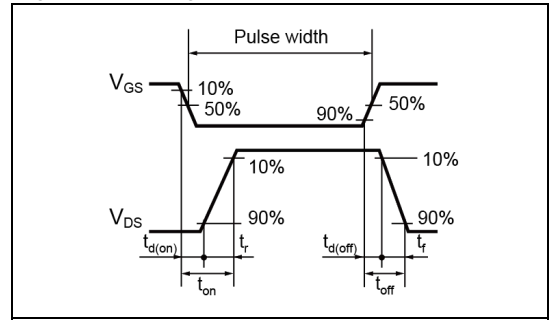

Fig.2-1 Gate Charge Measurement Circuit

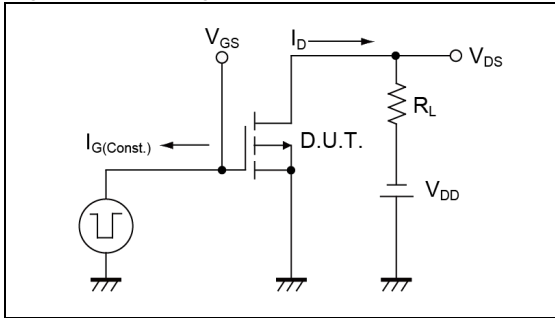

Fig.2-2 Gate Charge Waveform

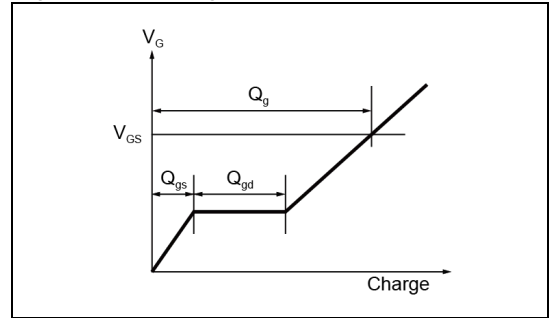

Fig.3-1 Avalanche Measurement Circuit

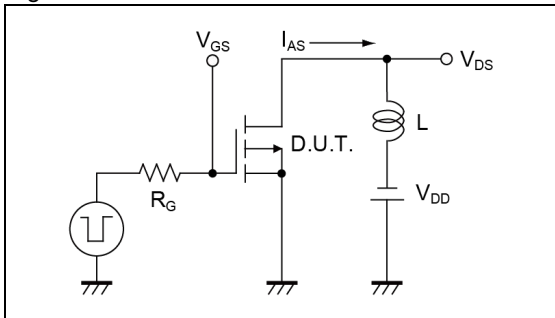
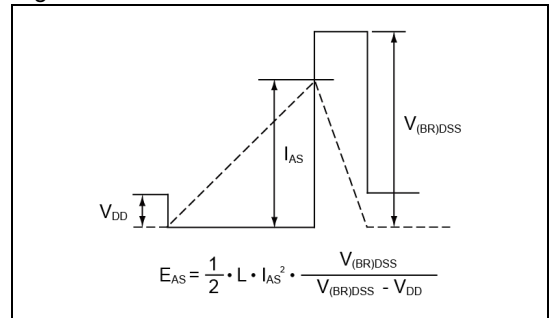

Fig.3-2 Avalanche Waveform



● Notice

This product might cause chip aging and breakdown under the large electrified environment. Please consider to design ESD protection circuit.

●Dimensions

HUML2020L8(Single)

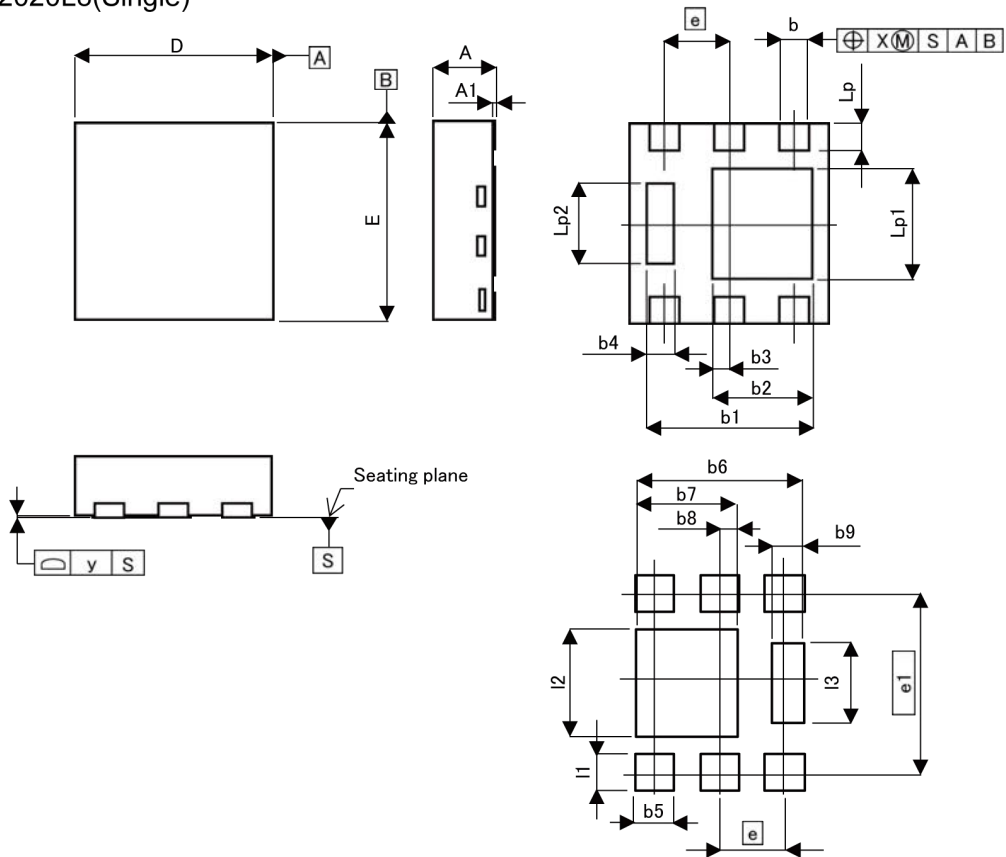

Pattern of terminal position areas
[Not a recommended pattern of soldering pads]

DIM	MILIMETERS		INCHES	
	MIN	MAX	MIN	MAX
A	0.55	0.65	0.022	0.026
A1	0.00	0.05	0.000	0.002
b	0.25	0.35	0.010	0.014
b1	1.55	1.75	0.061	0.069
b2	0.95	1.05	0.037	0.041
b3	0.175		0.007	
b4	0.20	0.30	0.008	0.012
D	1.90	2.10	0.075	0.083
E	1.90	2.10	0.075	0.083
e	0.65		0.026	
Lp	0.225	0.325	0.009	0.013
Lp1	1.05	1.15	0.041	0.045
Lp2	0.75	0.85	0.030	0.033
x	-	0.10	-	0.004
y	-	0.10	-	0.004
DIM	MILIMETERS		INCHES	
	MIN	MAX	MIN	MAX
b5	-	0.45	-	0.018
b6	-	1.75	-	0.069
b7	-	1.05	-	0.041
b8	0.175		0.007	
b9	-	0.30	-	0.012
e1	1.725		0.068	
l1	-	0.425	-	0.017
l2	-	1.15	-	0.045
l3	-	0.85	-	0.033

Dimension in mm/inches

